

# Part 3 | Waste & CO<sub>2</sub> Reduction Life Cycle Assessment

Graecia Lugito, Ph.D & Wibawa Hendra Saputera, PhD.

# Table of Contents

## Part 3 | Waste & CO<sub>2</sub> Reduction Life Cycle Assessment

1. Introduction	1
2. Methodology	4
3. Life Cycle Assessment	11
3.1 Plantation/Cultivation Value Chain .....	11
3.2 Mill Value Chain .....	14
3.3 Refinery Value Chain .....	23
3.4 Packaging and Distribution Value Chain .....	26
3.5 Consumption and Disposal Value Chain.....	29
4. Sociotechnical Options of Waste and CO <sub>2</sub> Reduction Strategies	31
References	38
Appendix 1: System Boundaries for LCA Analysis	40
Appendix 2: Inventory Background Data for LCA Analysis	49
Appendix 3: Detailed Foreground Data for LCA Analysis	54
Appendix 4: Detailed Foreground Data PT.SMART for LCA Analysis	57
Appendix 5: Detailed Foreground Data Refinery PT. SMART for LCA Analysis per 100 kg CPO in 2021	59

# 1. Introduction

The new global food emissions database (EDGAR-FOOD), which was built on the Emissions Database of Global Atmospheric Research (EDGAR) and land use/land-use change emissions from the FAOSTAT emissions database, shows that the most significant contributor to Greenhouse Gas (GHG) emissions is from the Food sector. For Developing Countries, the largest GHG emissions come from land use and land-use change (LULUC), followed by production, distribution, and end-of-life processes. The previous Quick Assessment/Rapid Assessment (QA/RA) study has discovered that the Palm Oil Processing industry (mill and refinery) is the most potential subsector for implementing circular economy and low carbon development policies in the Food Industry. Palm oil is a strategic export commodity that contributes to USD 18.3 billion of the national GDP, 16.2 million employment, and regional developments.<sup>1</sup> It has a growing market in the food and energy, cosmetics, and other industrial sectors. The growth of the palm oil industry has increased rapidly, with the plantation expansion almost doubling from 2010 -to 2020. As of 2019, the total land area of oil palm plantations in Indonesia achieved 16.38 million ha.<sup>2</sup>

In 2019, Indonesia produced 47.12 million metric tons of palm oil (more than half of global production).<sup>3</sup> On the other hand, palm oil plantations responsible for approximately 20-25 tons of CO<sub>2</sub>-eq emissions per hectare per year, or equal to 13.8% of national emissions.<sup>4,5</sup> Therefore, the palm oil industry can support the Indonesian government's commitment to achieving net zero-emission in 2060 by setting up mitigation activities, especially in the energy, agriculture, and waste sectors. Figure 1 shows the distribution of oil palm plantations in Indonesia. Most of the oil palm plantations (more than 60%) were located in Sumatera, Kalimantan, and Sulawesi. The government owns only 7% of the oil palm plantation areas, while the rest are owned by private companies (52%) and smallholders (41%).<sup>5</sup> The major privately-owned palm oil producers in Indonesia are PT. Astra Agro Lestari TBK, PT. Perusahaan Perkebunan London Sumatra Indonesia TBK, PT. Sinar Mas Agro Resources and Technology Tbk., and PT. Bakrie Sumatera Plantation Tbk.

---

<sup>1</sup> Tropenbos Indonesia, Info brief – Oktober 2020

<sup>2</sup> Surat Keputusan Menteri Pertanian No. 833/KPTS/SR.020/M/12/2019 tentang Penetapan Luas Tutupan Kelapa Sawit Indonesia Tahun 2019

<sup>3</sup> <https://www.statista.com/statistics/>

<sup>4</sup> <https://www.bpdp.or.id/en/research-shows-palm-oil-produces-lower-emission>, 12 March 2020

<sup>5</sup> Vita Dhian Lelyana, Mugiyanto, Agus Haryanto, The Potential Reducing of GHG Emission from Palm Oil Plantation and Mill in The Contribution of National Target.

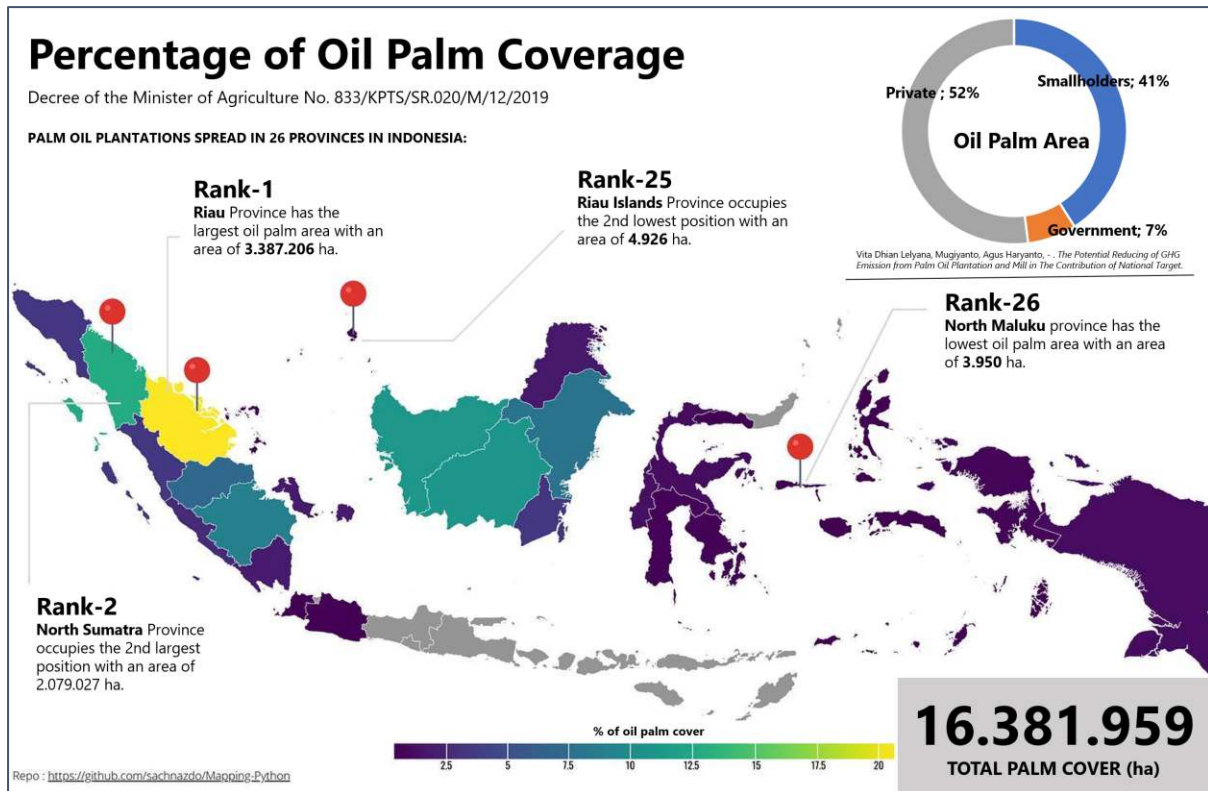

**Figure 1 Distribution of Palm Oil Plantation and Production in Indonesia <sup>2, 5</sup>**

Palm oil plantation development has been closely related to the issues of deforestation and the destruction of carbon-rich peatlands. However, as more and more international companies demand sustainable palm oil that meets the criteria of the Malaysia-based Roundtable on Sustainable Palm Oil (RSPO), in 2011, Indonesia established its own Indonesian Sustainable Palm Oil (ISPO), which aims to enhance the global competitiveness of Indonesian palm oil and brings it under stricter environmental legislation. As a result, all Indonesian palm oil producers are now compelled to receive ISPO certification. Until the end of June 2020, there were 621 ISPO certificates issued, covering an area of 5,450,329 ha of oil palm plantations, or 38.03% of the total area of oil palm plantations in Indonesia.<sup>6</sup> After Perpres No. 44/2020, all stakeholders (including smallholders) must have an ISPO certificate within 5 years. In addition, the establishment of sustainable Palm Oil Initiatives (SPOI) and the Indonesian Oil Palm Research Institute benefit from providing data for this study.

Production of cooking oil (refined palm oil olein) from the Indonesian palm oil refinery industry reached 15.5 MMt in 2009 (see Table 1). The production has grown rapidly, surpassing the growth of consumption. As a result, palm cooking oil local food consumption in Indonesia in 2021 was about 26.5 kg cooking oil per capita per year (approximately 8.95 MMt or almost 20 % of Indonesian CPO production were processed for local food consumption).<sup>7</sup> In a Publication in the Food Consumption Bulletin of the Ministry of Agriculture (2019), the production of palm cooking oil in Indonesia can meet the overall national consumption and

<sup>6</sup> Daily Investor Indonesia, 2020. Pemerintah Takkan Intervensi Penerbitan Sertifikat ISPO. Diunduh dari <https://investor.id/business/pemerintah-takkan-intervensipenerbitan-sertifikat-ispo>.

<sup>7</sup> Vegetable oils consumption per capita in Indonesia (Statista, 2021) - supported by GAPKI, 2021.

even be exported abroad with an estimated volume of 20.36 MMt. Data from the Large-Medium Industry (Industri Besar Sedang) survey shows 74 palm cooking oil factories in Indonesia, of which 45 factories are concentrated on Sumatra and Java Island (see Figure 2).<sup>8</sup>

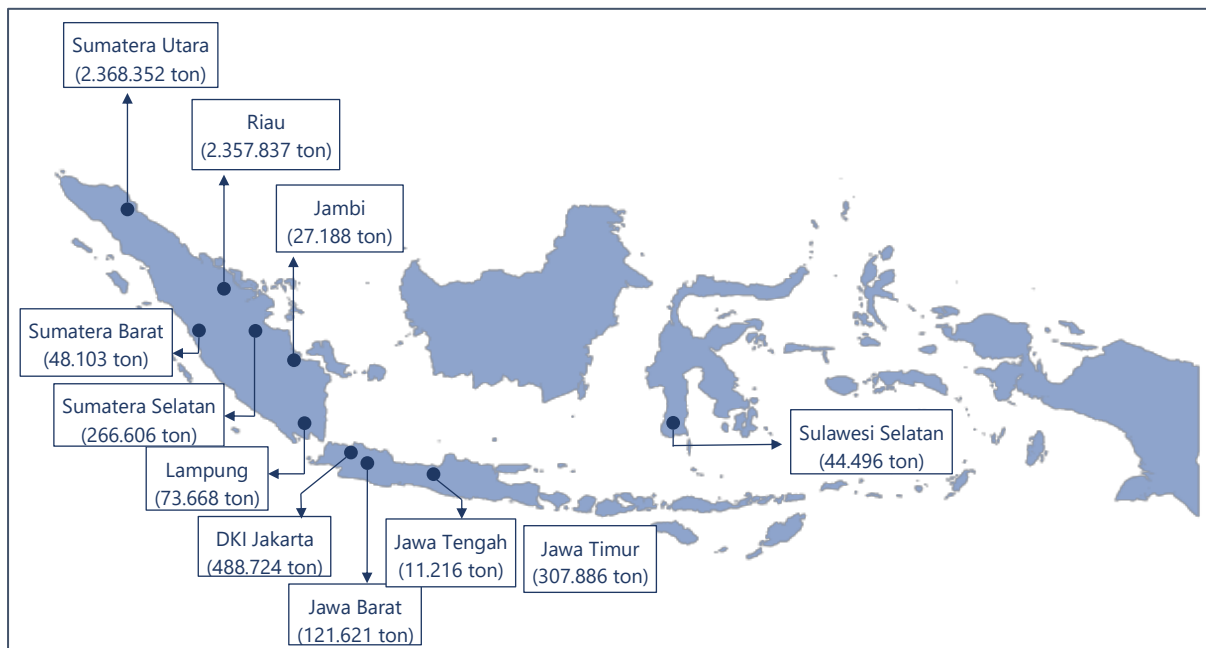

Figure 2 Indonesian Palm Oil Refinery Industry Profile<sup>9</sup>

Table 1 Production Capacity & Market Share of Cooking Oil Industries in 2009<sup>10</sup>

No	Shareholders	Production Capacity (Ton/year)	Market Share (%)
1	Wilmar Group (5 companies)	2,819,400	18.24
2	Musim Mas (6 companies)	2,109,000	13.64
3	Permata Hijau (3 companies)	932,000	6.03
4	PT Smart	713,027	4.61
5	Salim Group	654,900	4.24
6	PT Bina Karya Prima	370,000	2.39
7	PT Tunas Baru Lampung (Sungai Budi Group)	355,940	2.30
8	BEST Group	341,500	2.21
9	PT Pacific Palmindo Industri	310,800	2.01
10	PT Asian Agro Agung Jaya (RGM Group)	307,396	1.99
11	Others	6,542,637	42.33
<b>Total</b>		<b>15,456,600</b>	<b>100.00</b>



<sup>8</sup> BPS 2021 Distribusi Perdagangan Komoditas Minyak Goreng Indonesia

<sup>9</sup> Profil Komoditas Minyak Goreng, Kemenperin (2009).

<sup>10</sup> Profil Komoditas Minyak Goreng, Kemenperin (2009).

## 2. Methodology

The study consists of four stages (Figure 3), including literature review, data collection, data interpretation, and the sociotechnical option of waste and CO<sub>2</sub> reduction strategies. Data collection comprises focus group discussion and data requests to relevant stakeholders: PTPN-5 (PT. Perkebunan Nusantara V), PT SMART, GAPKI (Gabungan Pengusaha Kelapa Sawit Indonesia), and GIMNI (Gabungan Industri Minyak Nabati Indonesia) as government, private, and smallholders' representatives, respectively. Data have been calculated as global warming potential (GWP) through two approaches: manual calculation using actual data from stakeholders and SimaPro software comparing actual and inventory data. In general, this study will identify the upstream to downstream value chain to obtain the potential for waste and CO<sub>2</sub> reduction by finding its current life cycle (VSM) state. Then, the finding will lead to the technology available to reduce waste and CO<sub>2</sub> production to promote a circular economy, such as the waste-to-energy technology to transform current waste into energy as well as waste-to-byproduct to transform waste into biofertilizer. Next, the study will collect data in the technology portfolio to obtain comprehensive findings to reduce or transfer waste with every trade-off. Then, the assessment will be calculated based on the current state of food and beverage waste with the available technology considering CO<sub>2</sub> reduction, cost, and circular implementation. The output of this phase is the feasible technology and its performance to reduce waste and CO<sub>2</sub>, as shown in Figure 3 below.

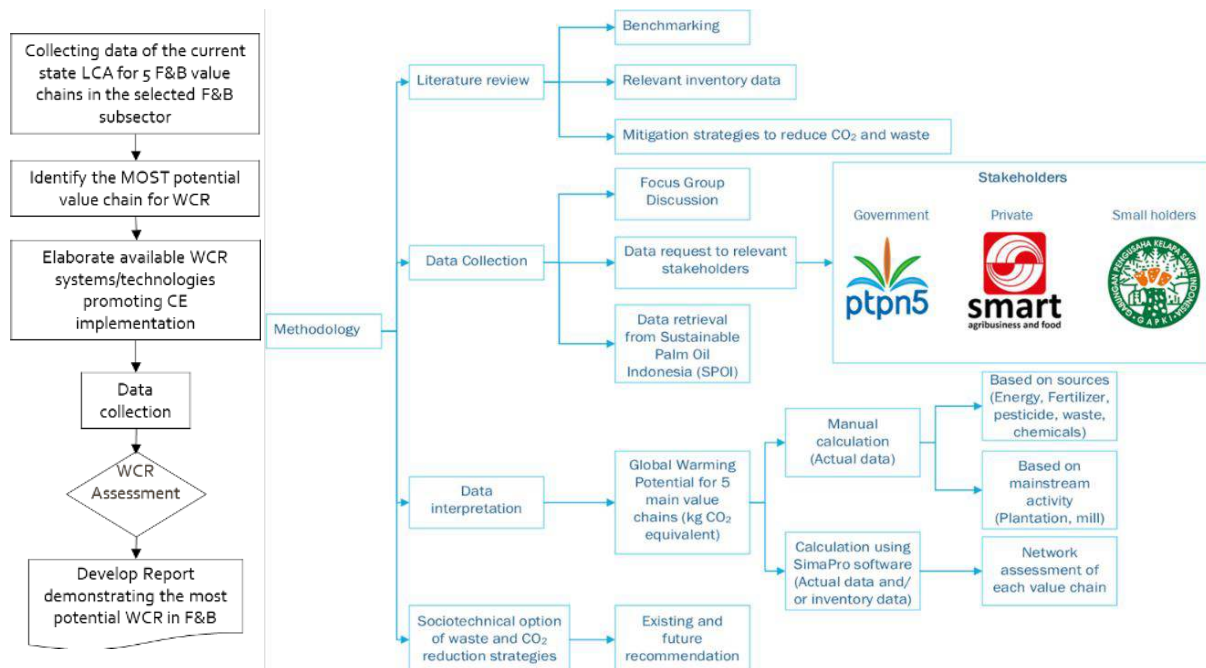
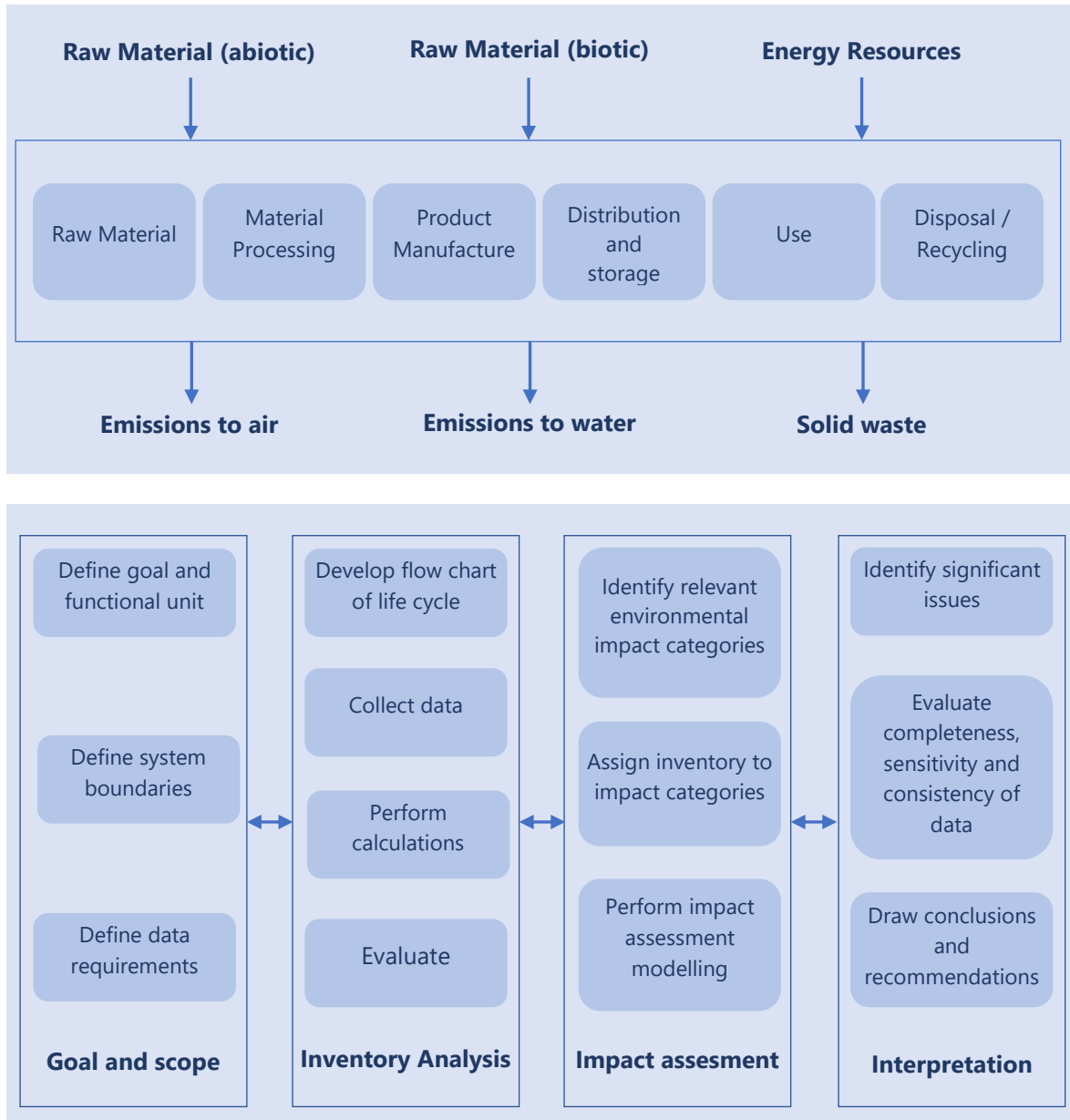

Figure 3 Methodology of WCR Potential Assessment



**Figure 4 Life Cycle Assessment Stages <sup>11</sup>**

The Life Cycle Assessment is conducted using a methodological framework based on ISO (International Standardization Organization) 14040 standards carried out using the SimaPro 9.3.0.3 software with secondary data obtained from the related industrial inventory adjusted to the domestic production and distribution capacity. A detailed step-by-step procedure for processing life cycle analysis (LCA) using SimaPro software is displayed in Figure 5. Inventory databases in this study comprise background data from Agri-footprint 5 – mass allocation and Ecoinvent 3 – allocation at point of substitution (APOS). In addition, an impact assessment was conducted under the ReCiPe 2016 Midpoint-Hierarchy Perspective. Furthermore, foreground inventory databases have also been collected through a survey. The assessments of

<sup>11</sup> Adapted from: Verghese K, Lockrey S, Clune S, Sivaraman D (2012) Life cycle assessment (LCA) of food and beverage packaging. Emerging Food Packaging Technologies Ch. 19, 380-408.

foreground data are conducted with software and manual calculations to show the variation of scenarios.

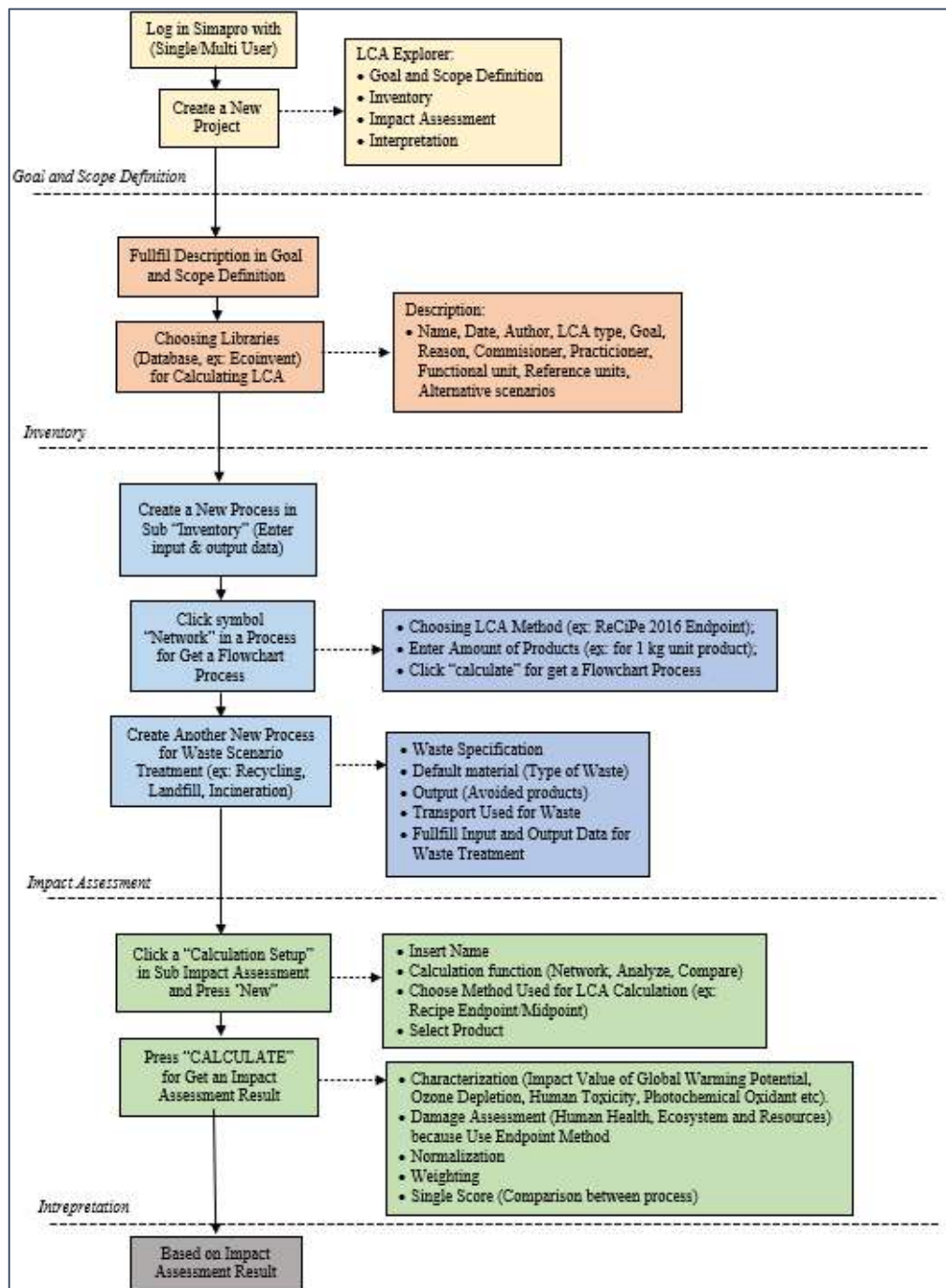

Figure 5 Detail Flowchart of Life Cycle Analysis (LCA) using SimaPro Software

LCA is carried out in 4 stages:

- 1) **Goal and scope** – Goal: determine the supply chain with the most significant potential in reducing waste and CO<sub>2</sub> output in the selected sub-sector. Prospective stakeholders include PTPN, PT. SMART, Tbk, GAPKI, and GIMNI. Scope: gate to gate or gate to the grave scenario, namely by analyzing raw materials that have been processed to disposal (without involving analysis of recycling, reuse, and ecological loop processes). The needed data are raw material consumption, processing, manufacturing, packaging



and distribution, consumption, and end-of-life/disposal. The functional unit used in this assessment is 100 kg CPO – 14.3 kg cooking oil (assumption 21% CPO is processed to fulfill local cooking oil demand) with system boundaries as follows:

- Raw materials: Palm oil, fresh fruit bunches
- Products: Crude palm oil (CPO) & cooking oil
- Material processing – is displayed in Figure 6
- Product manufacture: production of CPO & cooking oil
- Distribution & storage: transportation + plastic packaging
- Use: Consumption of cooking oil (26.5 kg per capita)
- Disposal/recycling: Palm oil mill effluent (POME) + Empty fruit bunch (EFB) & cooking oil recycle

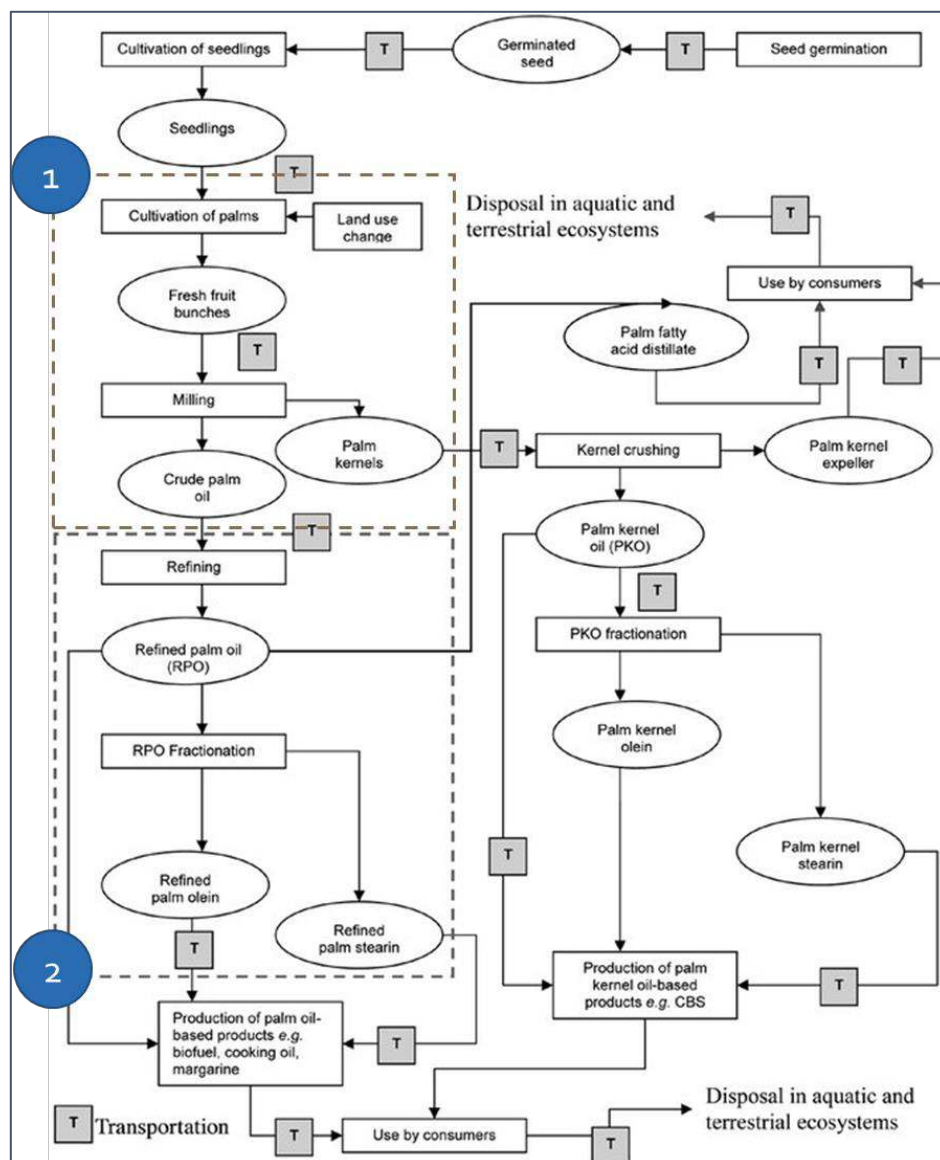
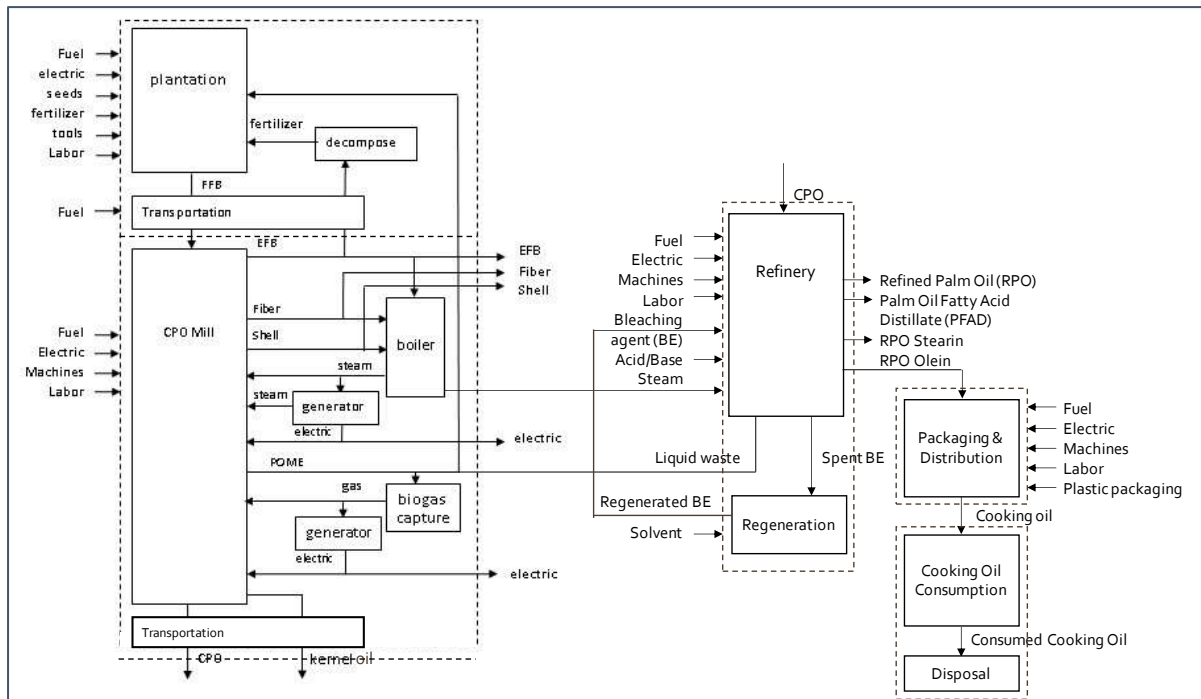

Figure 6 Scope of Study (1) CPO Production and (2) Cooking Oil Production <sup>12</sup>

<sup>12</sup> Adapted from: Tan YA, Halimah M, Zulkifli H, Subramaniam V, Puah CW, Chong CL, Ma AN, Choo YM (2010) Life cycle assessment of refined palm oil production and fractionation (Part 4). Journal of Oil Palm Research, 22, 913-926.



**Figure 7 System Boundaries for Plantation, Mill, Refinery, Packaging, and Distribution, as well as Consumption and Disposal**<sup>13</sup>

- 2) **Life cycle inventory** –a database of related industrial inventories provided by SimaPro software will be used as a reference to adjust to the production capacity and distribution of associated industries in the country. Some alternative LCI databases available at SimaPro include the renowned Ecoinvent V3 database, the industry-specific Agri-footprint database, the EU and GLO Input-Output database, and Industry data 2.0. Data collections are necessary to perform LCA and WCR analysis. It is classified into five main steps: plantation, mill, refinery, packaging and transport, and use and disposal (Figure 8).
- 3) **Life cycle impact assessment** – an assessment will be carried out on each supply chain that has the potential to reduce waste and CO<sub>2</sub>. Considering the Rapid/Quick Assessment study results, which are based on KBLI level 4, the impact of LULUC will be excluded from the discussion.
- 4) **Interpretation** – Select one of the supply chains with the most significant potential to reduce waste and CO<sub>2</sub> and then develop strategic policy recommendations for the selected sub-sector.

<sup>13</sup> Adapted from: Jaizuluddin Mahmud, Marimin, Erliza Hambali, Yandra Arkeman & Agus R. Hoetman. The Design of Net Energy Balance Optimization Model for Crude Palm Oil Production. Communications in Computer and Information Science (2015) 516:76-88

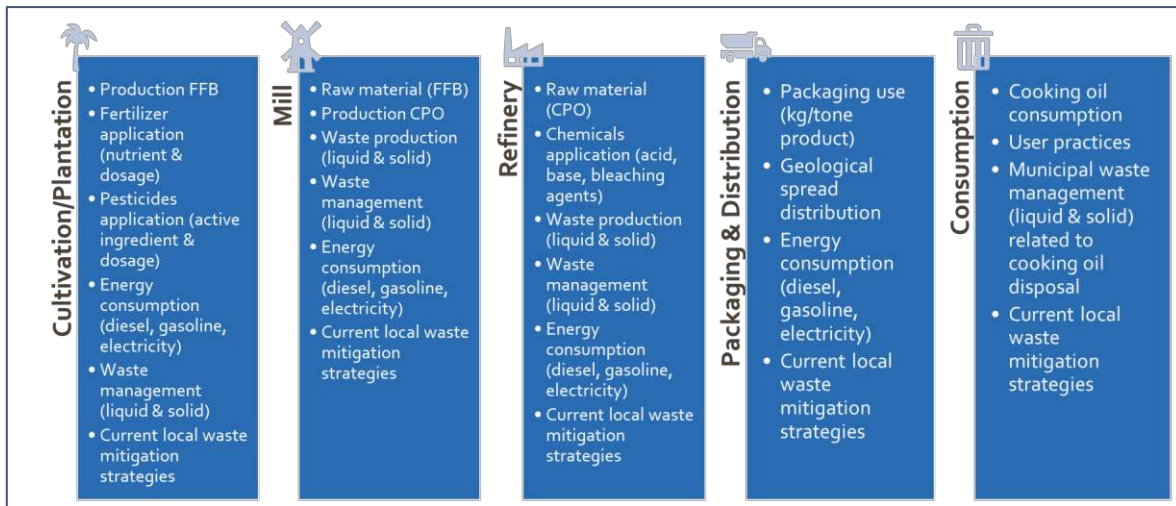

**Figure 8 List of Data Collections at Each Observed Chain**

This study will use performance and process indicators to report an in-depth assessment of Waste & CO<sub>2</sub> Reduction Potential in the Palm Oil Processing Industry Subsector. Performance indicators address what should be changed in our value chain, focusing on production steps and materials flows, showing where interventions are required. For example, performance indicators may include the waste generated within each step of the value chain, the share of secondary resources used within the production processes, or the recycling rate of the products. Process indicators address how the necessary change can be brought about, which links to culture, market failure, human behavior, operational activities, and institutional reform.

A recent study, *Decarbonizing the food and beverages industry: A critical and systematic review of developments, sociotechnical systems, and policy options*, has presented a comprehensive, critical and systematic review of more than 350,000 sources of evidence and a shortlist of 701 studies, on the topic of greenhouse gas emissions from the food and beverage industry. It utilizes a sociotechnical lens that examines food supply and agriculture, manufacturing, retail and distribution, and consumption and use. The review identifies the most carbon-intensive processes in the industry and the corresponding energy and carbon "footprints." Potentially transformative technologies are to be brought about as emerging options and practices for decarbonization providing benefits to decarbonization—including energy and carbon savings, cost savings, and other co-benefits related to sustainability or health—as well as barriers across financial and economic, institutional, and managerial, and behavioral and consumer dimensions. It also gives gleams on how financing, business models, and policy can be harnessed to overcome these barriers. The sociotechnical system approach used in explaining social and technological options for reducing waste production and CO<sub>2</sub> emissions is depicted in Figure 9.

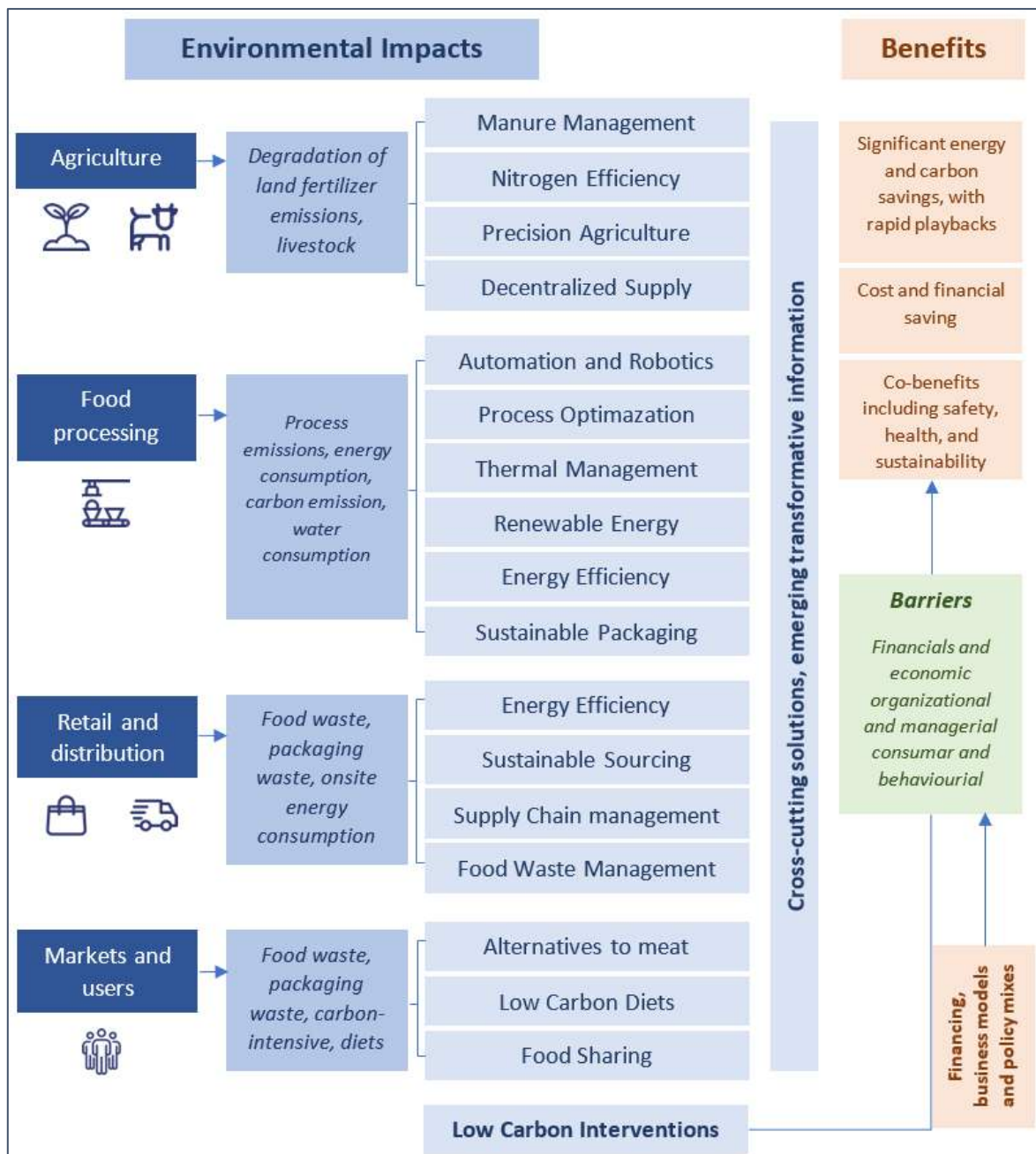

Figure 9 Interventions, Benefits, Barriers, and Policies for Decarbonizing the Food and Beverage Sociotechnical System <sup>14</sup>



<sup>14</sup> Sovacool BK, Bazilian M, Griffiths S, Kim J, Foley A, Rooney D (2021) Decarbonizing the food and beverages industry: A critical and systematic review of developments, sociotechnical systems and policy options. Renewable and Sustainable Energy Reviews, 143, 10856.

### 3. Life Cycle Assessment

Life cycle assessments have been conducted for five value chains (i.e., cultivation, mill, refinery, packaging, and distribution, as well as consumption and disposal). For plantation and mill, there are four scenario approaches (i.e., software assessment using Indonesian background database including LULUC, software assessment using Indonesian background database excluding LULUC, software assessment using foreground data excluding LULUC, and manual assessment using foreground data excluding LULUC). For refinery, there is an assumption of 20% refined-CPO (21% CPO) was process to fulfill local cooking oil demand (which is assumed to be 6 MMT in 2022).<sup>15</sup> Packaging and distribution assess only the 2L PET bottled – palm cooking oil as the most resource-extensive single-used packaging. While consumption and disposal assessments were conducted with the premise that vegetable cooking oil is carbon neutral, meaning CO<sub>2</sub> released when burned is the same as CO<sub>2</sub> taken by plants to grow. Thus, the approach comes from using used cooking oil as raw material for biodiesel production.

#### 3.1 Plantation/Cultivation Value Chain

Oil palm fruit cultivation in Indonesia considers seeding, plantation, fertilizer, lime, and pesticide application rates and their production, capital goods depreciation, and energy use for field management and irrigation (see Figure 10). The elementary flows include field emissions to the air, water, and soil, direct land use change emissions, and emissions due to pesticide use and heavy metal emissions.

The LCI is taken from Agri Footprint 5 – mass allocation background data for the first and second scenarios. For background data scenarios, crop yields are derived from FAO statistics using a 5-year average (2012-2016). Possible co-production is in line with the Agri-footprint methodology. Synthetic fertilizer use is 86.77 kg N, 59.97 kg P<sub>2</sub>O<sub>5</sub> and 134.26 kg K<sub>2</sub>O equivalents, based on the NPK model. Specific fertilizer amount is quantified based on total NPK and relative amounts of fertilizer consumed by type for the region of Indonesia.<sup>16</sup>

For arable cultivations, animal manure is applied for soil maintenance based on the methodology described in Appendix 4 of Vellinga et al. (2013).<sup>17</sup> Nutritional input from manure for this type of cultivation is 0.00 kg N and 0.00 kg P<sub>2</sub>O<sub>5</sub> equivalents, based on data from FAOSTAT (2012-2016). Seven heavy metal emissions from synthetic fertilizer, manure, and lime use have been calculated based on an adapted methodology.<sup>18</sup> It is taken into account the heavy metal balance as a function of deposition, use of fertilizer, and crop uptake using

---

<sup>15</sup> GAPKI, 2021 supported by statement from Menteri Perdagangan, 2022

<sup>16</sup> IFA (2011). Personal communication. Director Agriculture and Environment, Fertilisers Europe, Brussels.

<sup>17</sup> Vellinga, T. V., Blonk, H., Marinussen, M., Zeist, W. J. Van, Boer, I. J. M. De, & Starmans, D. (2013).

Methodology used in feedprint: a tool quantifying greenhouse gas emissions of feed production and utilization.

<sup>18</sup> Nemecek & Schnetzer (2012). Methods of assessment of direct field emissions for LCIs of agricultural production systems.

literature concerning heavy metal contents of manure (Amlinger et al. 2004) and fertilizers and lime (Mels, Bisschop & Swart, 2008)<sup>19</sup> and crop uptake (Delahaye et al. 2003).<sup>20</sup>

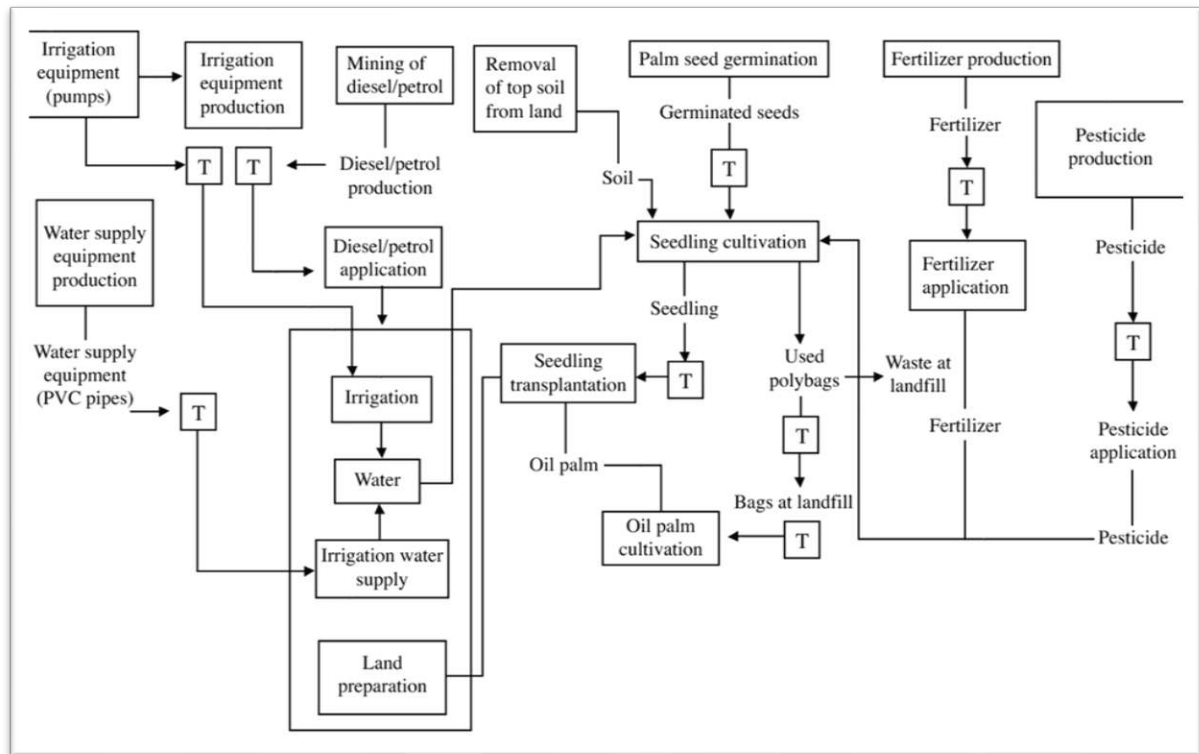

**Figure 10 Flow Chart for Palm Oil Seedling**<sup>21</sup>

Total water use is based on the 'blue water footprint' of Oil palm fruit in Indonesia, thus water needed could be counted as 0.00 m<sup>3</sup>/ton.<sup>22</sup> Therefore, it was chosen not to include a 'green water footprint' of 904.04 m<sup>3</sup>/ton of total rainwater of 15441.56 m<sup>3</sup>/ha in the dataset.

Energy use for arable and orchard cultivations was calculated based on the 'Energy model for crop cultivation, which includes energy requirements for nine different agricultural activities. Various inputs are used for the energy model, including yield, irrigation water use, and different type of tillage techniques applied worldwide. For horticultural cultivations, the amount of energy is based on the 'Energy model for horticulture,' which includes climate conditions to estimate heat and electricity demand for cultivation.

Total pesticide use is based on the 'Pesticide model,' which determines the amount of insecticide, fungicide, and herbicide specific for crop country combination. Pesticide emissions are based on the most common active ingredients for the global region. LCI for Plantation scenarios 1 and 2 are available as Supporting Information.

<sup>19</sup> Mels, A., Bisschops, I., & Swart, B. (2008). Zware metalen in meststoffen - vergelijking van urine en zwart water met in Nederland toegepaste meststoffen.

<sup>20</sup> Delahaye, R. Fong, P. Van Eerd, M. (2003). Emissie van zeven zware metalen naar landbouwgronden.

<sup>21</sup> Halimah, et al. (2010). Journal of Oil Palm Research 22:878-886.

<sup>22</sup> Mekonnen, M. M., & Hoekstra, A. Y. (2010). The green, blue and grey water footprint of crops and derived crop products - Volume 1: Main Report (Vol. 1).

Land transformations are responsible for 770 kg CO<sub>2</sub>-eq/100 kg produced CPO (96.4%wt of total CO<sub>2</sub> emission). By excluding the land transformations from the assessment, the total CO<sub>2</sub> emissions from plantations were reduced to 28.7 kg CO<sub>2</sub>-eq/100 kg produced CPO, and Fertilizers take the first major responsibility of about 20.8%. In contrast, energy for machinery comes second with 3.77%, and plantation infrastructure comes third with 3.56%. Figure 11 and Figure 12 show the network assessment of plantation scenarios 1 and 2, respectively.

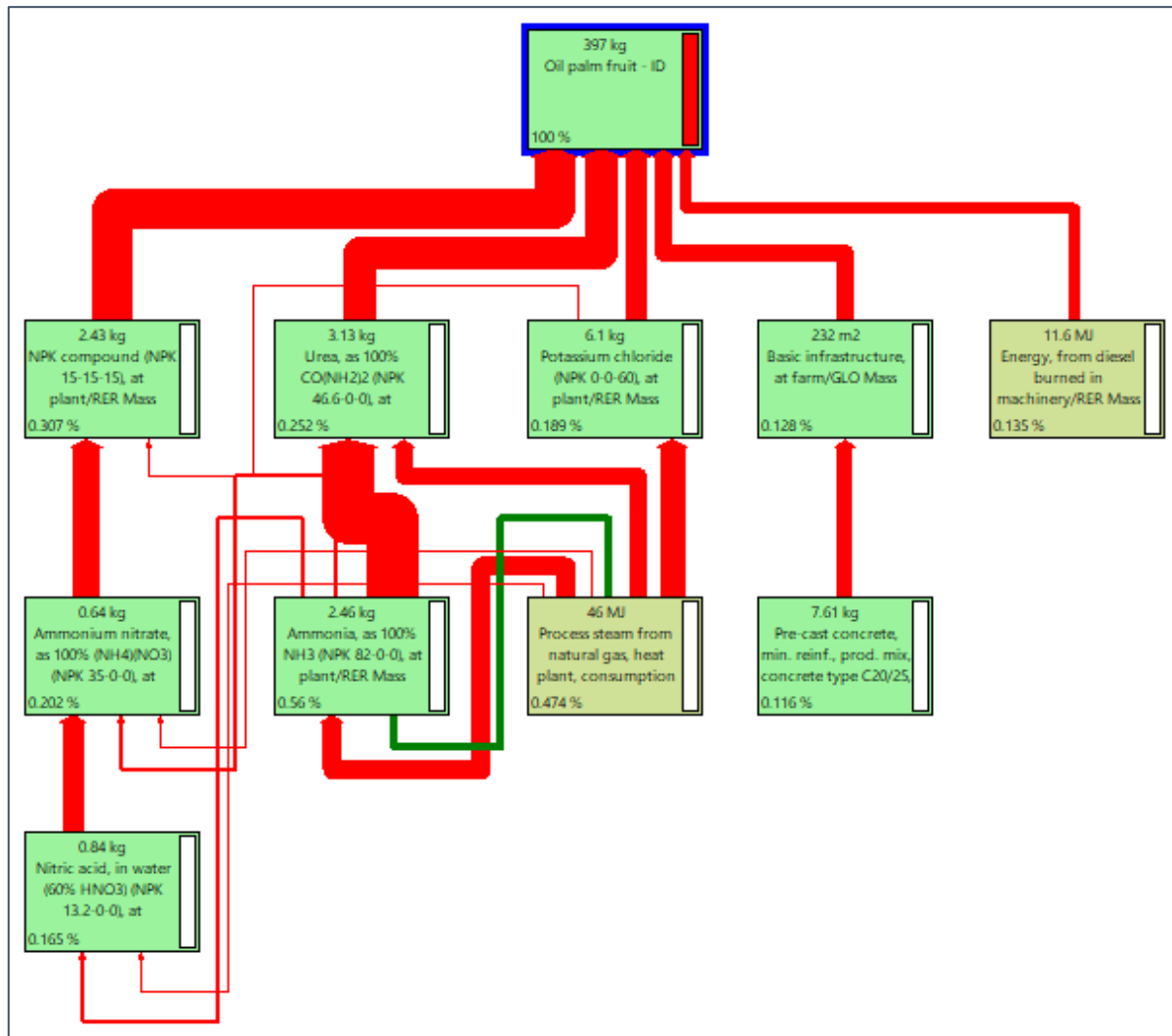

Figure 11 Network Assessment of the Plantation Scenario 1 (Background Data with LULUC)

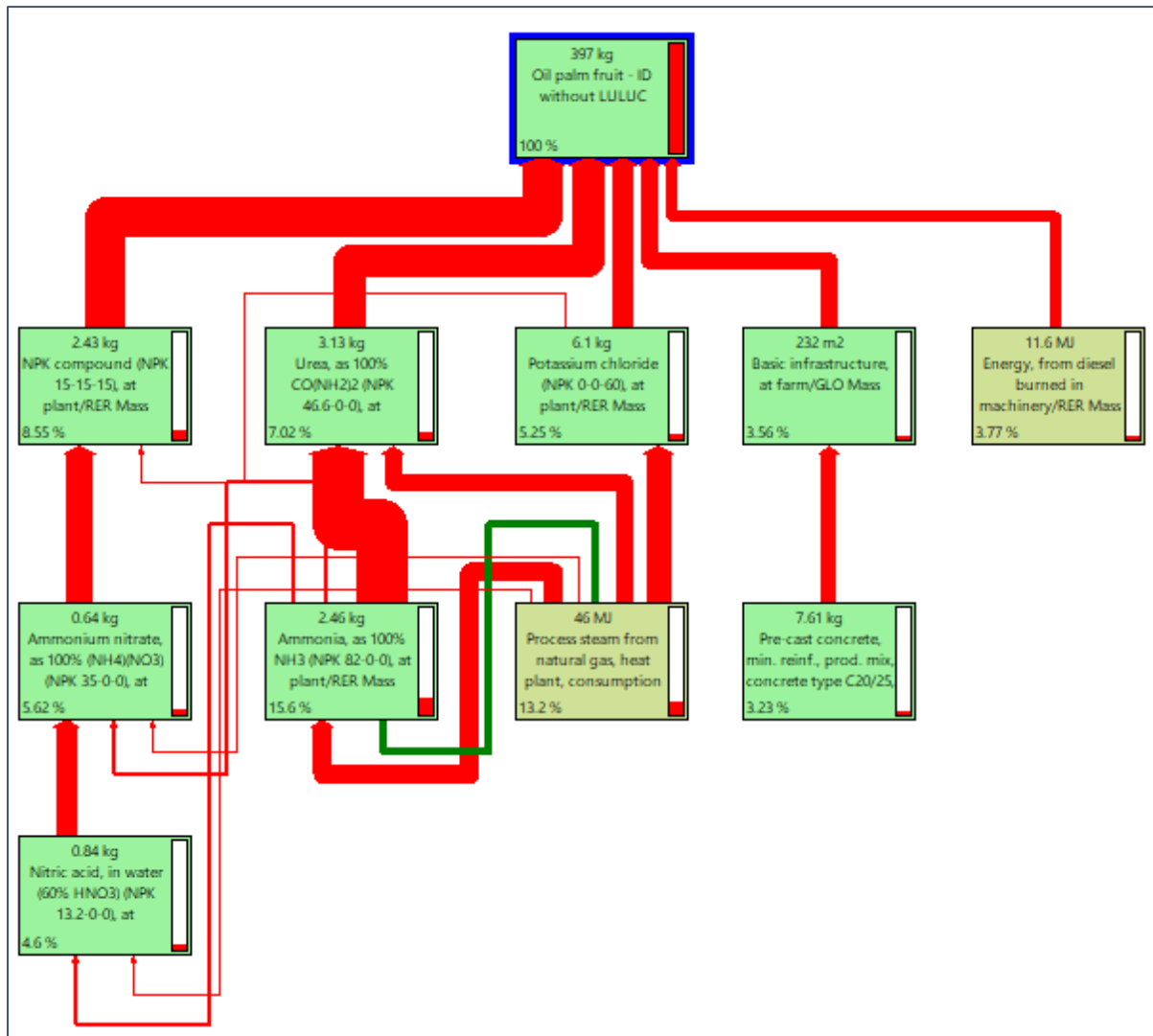

Figure 12 Network Assessment of the Plantation Scenario 2 (Background Data without LULUC)

### 3.2 Mill Value Chain

The palm oil mill in Indonesia considers palm fruit sterilization, stripping, crushing, palm oil extraction, and CPO drying and purification. Modern mill stations generate steam and electricity from a boiler through heat recovery from fiber and shells collected from solid waste. Treatment of palm oil mill effluent (POME) sludge has also been developed to recover the methane. Figure 13 shows the flow chart for palm oil mills. LCI for Mill scenarios 1 and 2 are available as Supporting Information. According to the Agri footprint data inventory, production of 100 kg CPO needs 397 kg oil palm fruit and 23.6MJ energy as well as generates 171 kg solid waste and 403 kg waste water to be treated.

Palm oil mills contribute to 207 kg CO<sub>2</sub>-eq/100 kg produced CPO comprises landfill of biodegradable solid waste (44.9%) and wastewater treatment (4.9%). Thus, waste took 49.8% of the total Palm oil mills CO<sub>2</sub> emission or about 103 kg CO<sub>2</sub>-eq/100 kg produced CPO. Figure 14 and Figure 15 show the network assessment of palm oil mill for scenarios 1 and 2, respectively.



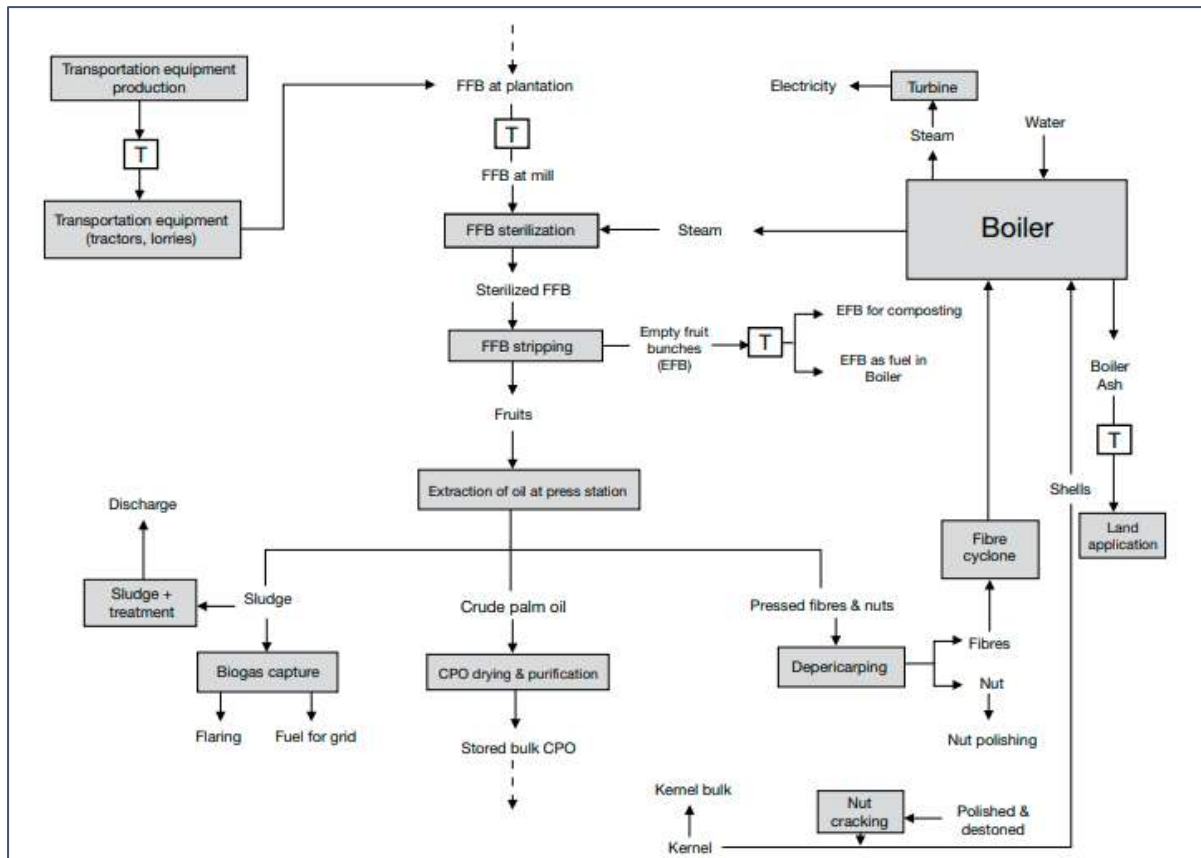

Figure 13 Flow Chart for Palm Oil Mills <sup>23</sup>

**Error! Reference source not found.** summarizes the CO<sub>2</sub>-eq emissions of the most contributing activities in plantation and mill value chains according to scenarios 1 and 2. Land transformations took a place only once at the beginning of plantation and the land could be utilized for long time afterwards; consideration to LULUC may not be relevant for this study. Excluding the LULUC, generated solid and liquid waste from mill value chain become the largest contributor to the total emission (103 kg CO<sub>2</sub>-eq/100kg produced CPO); while the emission from the use and transport of chemicals (fertilizers, pesticides, and fungicides) in plantation value chain reaches 26 kg CO<sub>2</sub>-eq/100kg produced CPO.

Plantation soil is composed of 40% Alluvial and 60% peat soil. Without remediation, the soil is not fertile and therefore needs excess of chemical fertilizers. On the other hand, waste from the mills contains minerals that could provide nutrients for the soil, increase the C/N ratio of the soil, and reduce the need of chemical fertilizers. The waste also produces methane that if not converted into energy, would end up generating equivalent to 23 times CO<sub>2</sub> emission. Converting wastes into bio/organic fertilizers and energy could be expected to reduce 20-30% CO<sub>2</sub> emission from the activities.

<sup>23</sup> Vijaya, et al. (2010). Journal of Oil Palm Research 22:895-903.

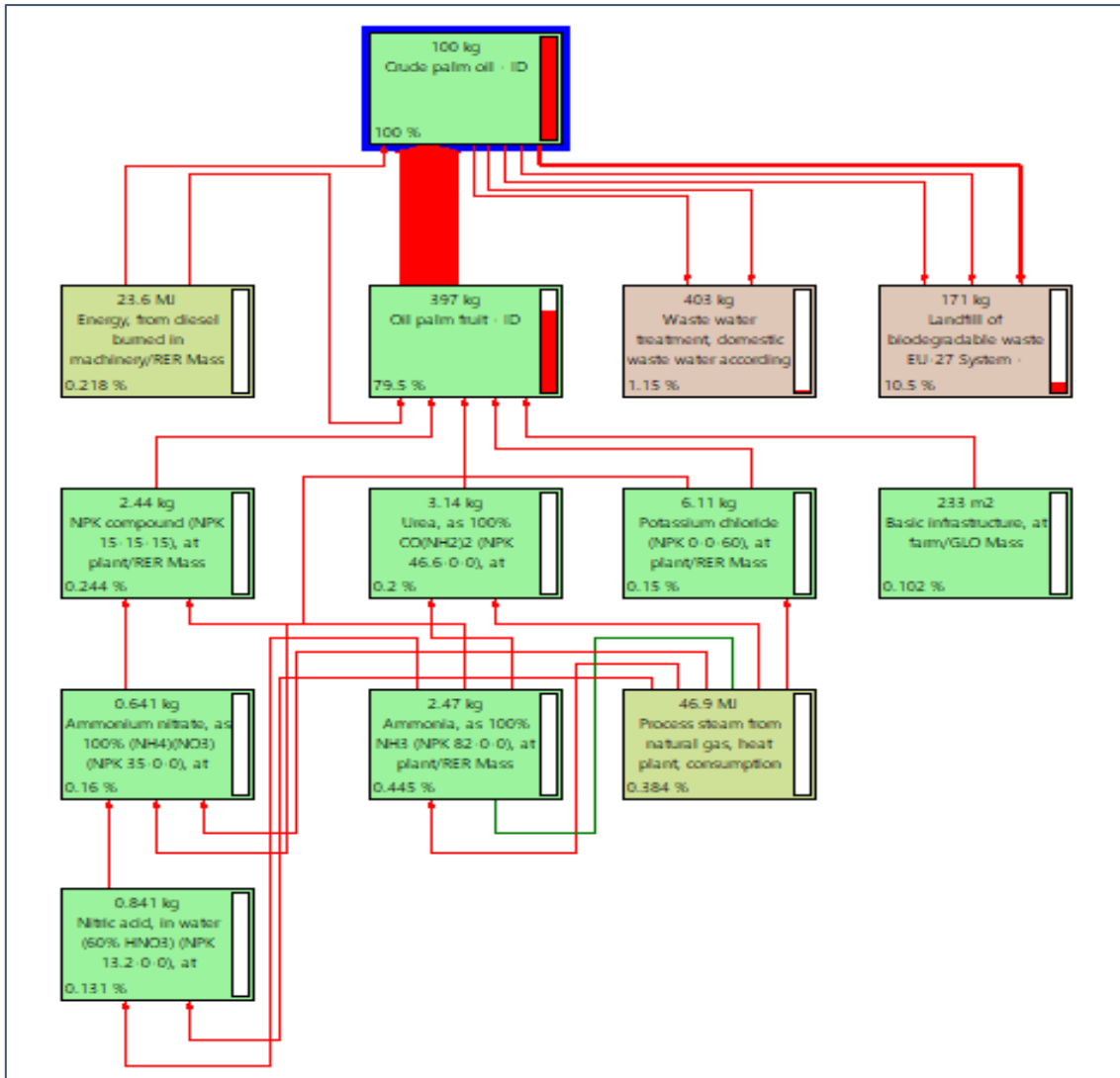

Figure 14 Network Assessment of the Mill Scenario 1 (Background Data With LULUC)

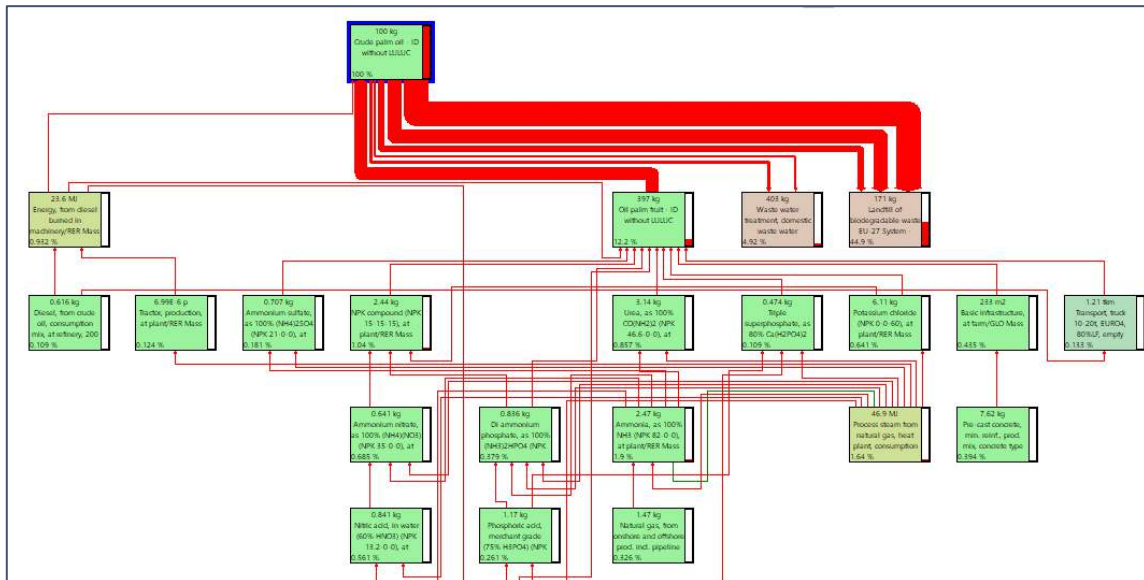
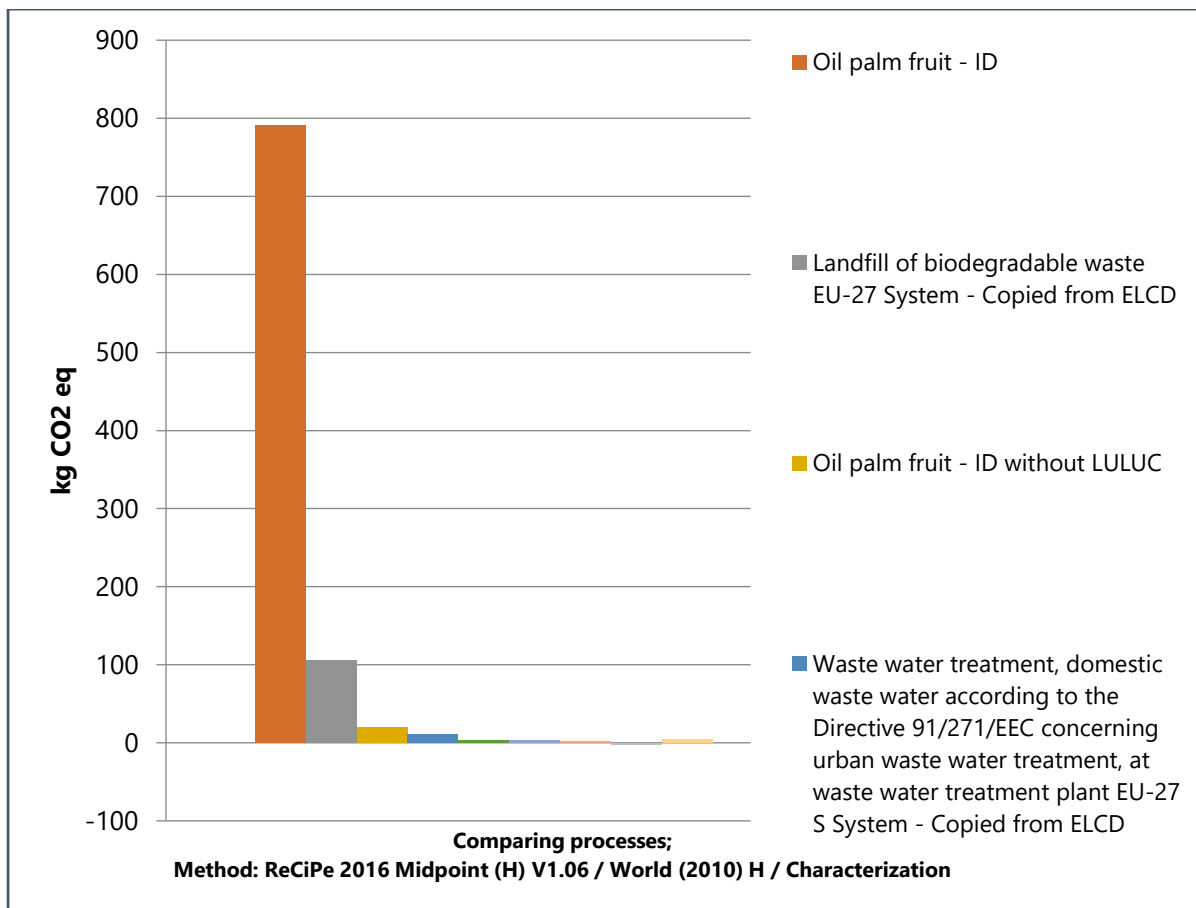

Figure 15 Network Assessment of the Mill Scenario 2 (Background Data Without LULUC)



**Figure 16 Life Cycle Impact Assessment of Plantation and Mill on Global Warming**

One of the targeted government stakeholders for this study is PT Perkebunan Nusantara V, commonly abbreviated as PTPN V. PTPN V is a PTPN III subsidiary engaged in oil palm and rubber plantations. PTPN V is headquartered in Pekanbaru, Riau. To process palm oil commodities, the Company has 12 units of Palm Oil Mills (PKS) with a total installed processing capacity of 570 tons of fresh fruit bunches (FFB) per hour with processed products in the form of palm oil and palm kernel. Then to further process palm kernel commodity, the Company has 1 unit of Palm Kernel Oil Mill with an installed capacity of 400 tons of palm kernel/day with processed products in the form of Palm Kernel Oil (PKO) and Palm Kernel Meal (PKM).

Plant area management is currently entering the transition from the first crop cycle (Gen-1) to the second crop cycle (Gen-2). The first cycle began in the 1980s through plantation development projects for former PT Perkebunan (PTP) II, IV, and V in Riau Province. The transition from Gen-1 to Gen-2 started in 2003, marked by replanting areas of old/old plants whose economic value has decreased. The transition phase from Gen-1 to Gen-2 is estimated to be completed in 2017. At that time, all of the Company's plants were Gen-2 plants expected to be more productive than Gen-1, as the fruit of continued innovation in plant cultivation.

PTPN V provided the data from each of 12 units of PKS, including:

- a. Production amount of Crude Palm oil.
- b. Energy used (diesel, electricity, and energy intensity).
- c. Materials and chemicals used (fertilizer, pesticides, and other chemicals).

- d. Water used (water sources and water intensity).
- e. Existing mitigations strategies for waste and CO2 reduction

The detailed aggregate data of the following parameters for each PKS in 2021 can be seen in Table 2 with aggregated inventory data as follows:

**Table 2 Aggregate Inventory Data of PKS in 2021**

<b>Plantation area</b>	1,933	Ha
<b>Total Palm</b>	274,551	palm
<b>Unit Functional</b>	100	kg CPO
<b>Productivity</b>	23	ton/Ha/year
<b>Potential production of TBS</b>	0.004	100 kg CPO/palm/year

**Table 3 Foreground Data Inventory from 12 Oil Palm Plantations in 2021**

No	Process	Mass	Substance	Unit	Total
1	Plants produce	Energy	Diesel fuel	Liter	99,343
			Electricity	kWh	2,023,333
			Energy intensity	kW/Production amount	12
		Fertilizer	1. Urea	Kg	241,681
			2. Dolomite	Kg	295,905
			3. MOP	Kg	57,270
			4. Kieserit	Kg	2,346
			5. Borate	Kg	246,80
		Pesticide	1. Amcofur	Kg	43,25
			2. Nara Up	Kg	3,273
			3. Racumin	Kg	228,25
			4. Marshall	Kg	1,000
			5. Santrino	Kg	133,46
Transportation	Distance	km	1,292,608		
2	Extraction of CPO	Water	Surface Water (River)	m <sup>3</sup>	502,018
			Water intensity	m <sup>3</sup> /Production amount	3
			Diesel fuel	liter	99,343
			Production of CPO	ton	30,672

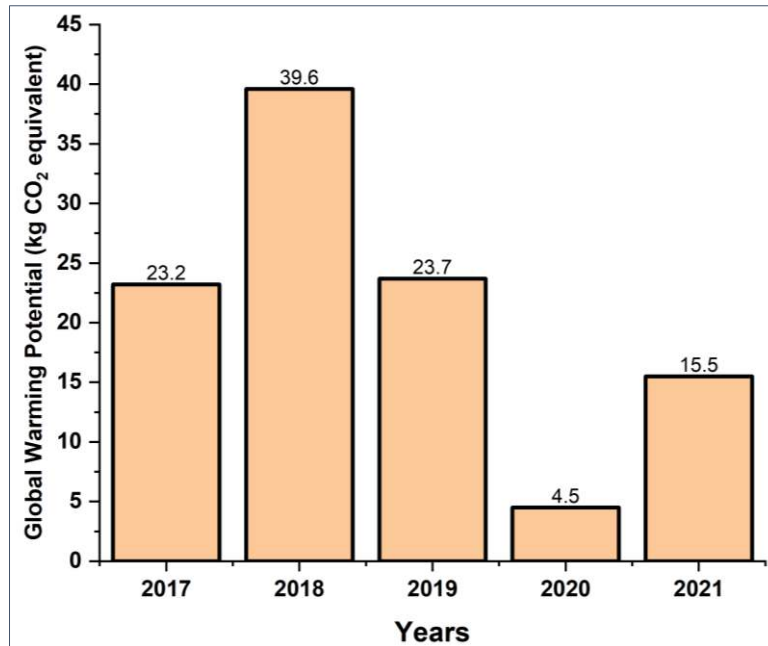
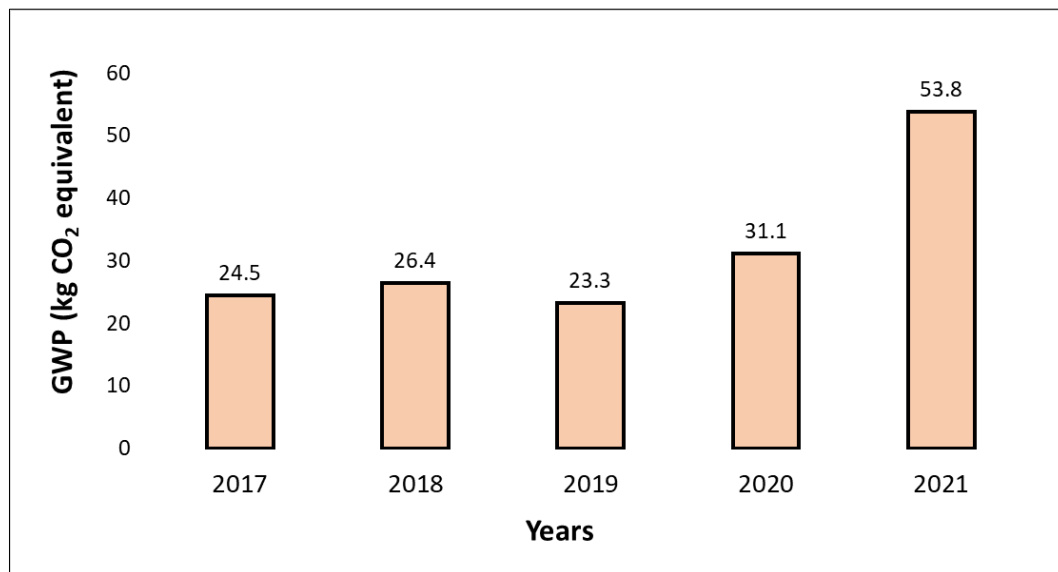

**Figure 17 GWP of Oil Palm Plantation and Mill Value Change in PTPN V – Software Calculated from Foreground Data Without Consideration to LULUC**

The detailed aggregate data from 12 units of PKS in the interval year 2017 until 2021 is displayed in Appendix 3. All parameters use a basis of 100 kg crude palm oil (CPO) production. Furthermore, global warming potential (GWP) is calculated using this data for each year (Figure 17). Based on Figure 17, it can be seen that the GWP in 2018 and 2020 exhibits the highest and lowest values, respectively. Based on the data in Appendix 3, in 2018, the use of fertilizers and pesticides significantly improved compared to other years. Fertilizers produce greenhouse gases after farmers apply them to their fields. Crops only take up, on average, about half of the nitrogen they get from fertilizers (Ref). Much of the applied fertilizer runs into waterways or gets broken down by microbes in the soil, releasing the potent greenhouse gas nitrous oxide into the atmosphere. Although nitrous oxide accounts for only a tiny fraction of worldwide greenhouse gas emissions (Ref), nitrous oxide warms the planet 300 times as much as carbon dioxide. In addition, Pesticides impact climate change throughout their manufacture, transport, and application. When pesticides are made, three main greenhouse gases are emitted: carbon dioxide, methane, and nitrous oxide. Thus, these two parameters (fertilizers and pesticides) contribute significantly to global warming potential assessment. Therefore, POME waste and empty fruit bunch (EFB) can be used as liquid and organic fertilizers in palm oil industries to tackle this problem.

On the other hand, in 2020, it shows the lowest GWP due to the lowest electricity usage (approximately 7-10 times lower compared to 2017-2019). However, since PTPN V still uses fossil fuels for electricity production, carbon dioxide (CO<sub>2</sub>) makes up the vast majority of greenhouse gas emissions from the electricity, with additional smaller amounts of methane (CH<sub>4</sub>) and nitrous oxide (N<sub>2</sub>O) also emitted, which are released during the combustion of fossil fuels, such as coal, oil, and natural gas. To tackle this problem, several strategies can be implemented, including (i) Increased Efficiency of Fossil-fired Power Plants and Fuel Switching and (ii) using renewable energy (wind, solar, hydro, and geothermal sources, as well as specific biofuel sources) through the addition of new renewable energy generating capacity (iii)

implementation of carbon capture utilization and storage (CCUS) technologies to reduce CO<sub>2</sub> emission.

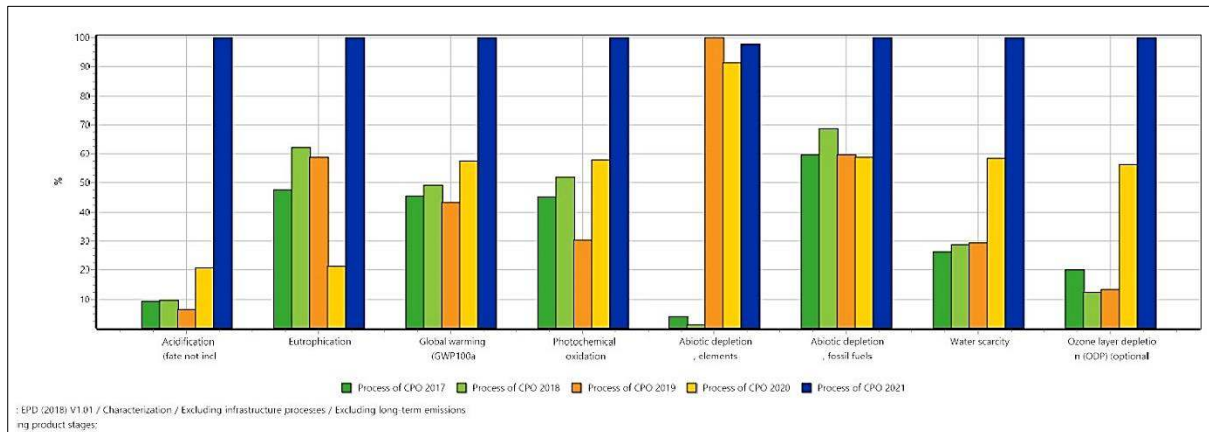

**Figure 18 GWP of Oil Palm Plantation and Mill Value Change in PT. SMART– Software Calculated from Foreground Data Without Consideration to LULUC**

Figure 18 shows calculation GWP of oil palm plantation and mill value change from primary data PT. SMART with using software calculation in the interval year 2017 – 2021. All parameters input and output have been converted for basis of 100 kg crude palm oil (CPO) production. Based on Figure 18, the GWP in 2021 and 2019 show the highest and lowest, with concentration GWP amount 53.8 kg CO<sub>2</sub> eq emissions and 23.3 kg CO<sub>2</sub> eq emissions, respectively. In 2021, GWP value is the highest compared other years. Based on the basis data in Appendix 4, the use of electricity, chemicals and fertilizers in 2021 that possibly cause the largest impact of GWP. The used fertilizers in 2021 is the largest compared to other years, such Muriate of Potash/MOP/KCl, Rock Phosphate and Super Dolomite. Much of the used fertilizer runs into a large amount of emission by affect to the soil and immediately releasing the potent greenhouse gas such NO<sub>2</sub> into atmosphere. On the other hand, the use of chemicals was also considered to become a factor that produced a high GWP concentration. One of chemicals that contributes to GWP value is Calcium Carbonate (CaCO<sub>3</sub>). In 2021, the use of CaCO<sub>3</sub> reach 311.350 kg for one time production. Based on CaCO<sub>3</sub> cycle, CaCO<sub>3</sub> will produce CO<sub>2</sub> as a product if there is a thermal decomposition into lime (CaO), whereas CO<sub>2</sub> is one of emission affect global warming. Much of the used CaCO<sub>3</sub> will affect the concentration of CO<sub>2</sub>. In 2021, NO<sub>x</sub> has the highest concentration compared to other years for 262.50 N/m<sup>3</sup>. The high concentration of NO<sub>x</sub> can be caused by using large amounts of fertilizers.

In 2019, shows the lowest GWP is responsible for 23.3 kg CO<sub>2</sub> eq emissions, respectively. GWP value in 2019 approximately almost 3 times lower compared to 2021. It is also cause from the use of electricity, fertilizer substance and chemicals. Several emissions that produced from used of fertilizers and chemicals are TSP, NO<sub>x</sub> and O<sub>3</sub>, with TSP is the highest concentration. All emissions potentially affect global warming. To tackle this problem, one of strategie can be implemented, there is using renewable energy (wind, solar, hydro, and geothermal sources, as

well as specific biofuel sources) to replace electricity usage and will minimize emission generated.



**Figure 19 Comparison GWP of Oil Palm Plantation and Mill Value Change in PT. SMART Interval 2017-2021 – Software Calculated from Foreground Data Without Consideration to LULUC**

The comparison GWP of oil palm plantation and mill value change from primary data PT. SMART interval 2017 – 2021 can be seen in Figure 19. Based on that figure, the production of Crude Palm Oil (CPO) in 2021 produced the highest GWP value compared to other years. Besides, this chain also produced other impacts, such as Acidification, Eutrophication, Photochemical Oxidation, Abiotic Depletion, Water Scarcity, and Ozone Layer Depletion.

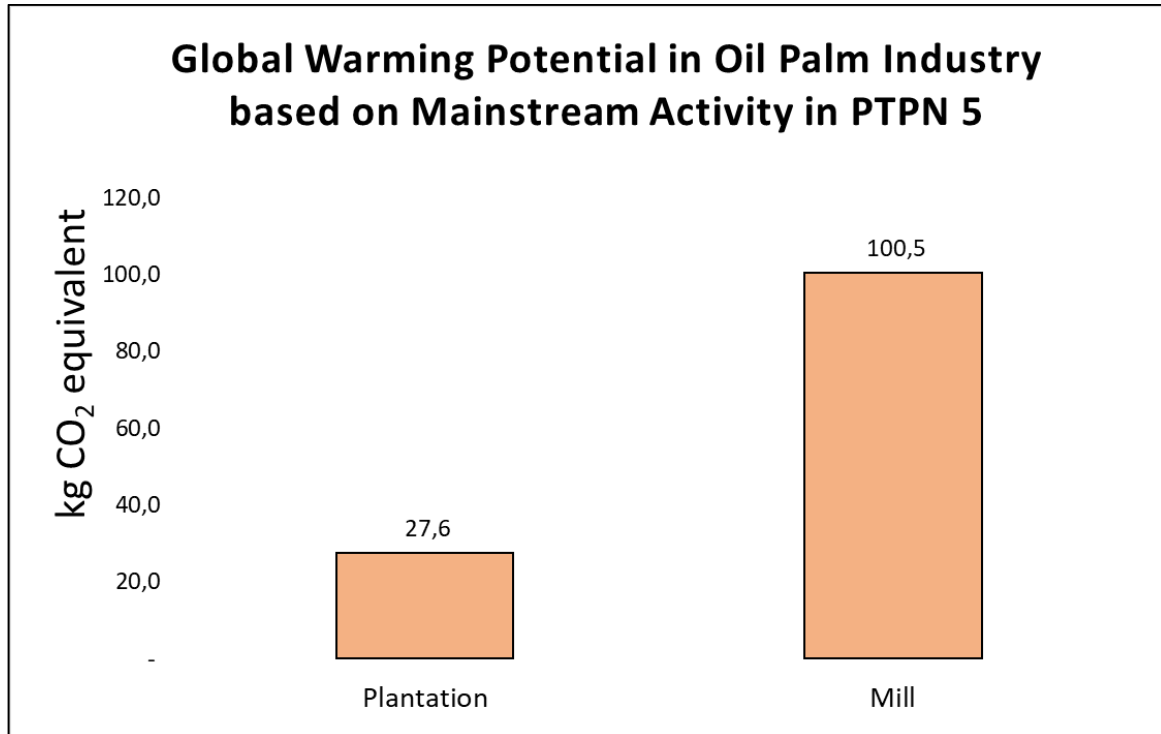

**Figure 18 GWP of Oil Palm Plantation and Mill Value Change in PTPN 5 – Calculated Manually from Foreground Data Without Consideration to LULUC**

The scope of manual LCA calculation is cradled to gate; system boundary starts from palm seedling (12 months) and continues to the planting process, immature palm (36 months), mature palm, harvesting, and CPO extraction. The data used primary data from PTPN 5 PKS TPU and PT. SMART. The CO<sub>2</sub> equivalent is calculated by a manual formula using the number of substances from the system product cycle, multiplied by the emission factor and the characterization factor. With a functional unit of 100 kg CPO, it is found that plantation and mill are responsible for 27.6 and 100.5 kg CO<sub>2</sub> eq emissions, respectively.

Observation of foreground data from PT. SMART showed alignment with foreground data from PTPN V, it is found that plantation and mill are responsible for 30,64 and 100,31 CO<sub>2</sub> eq emissions, respectively. Highest contribution, caused by fertilizer substance in plantation and waste in mill activity. **Thus, the manual calculation from PTPN 5 and PT. SMART results align with the software background data calculation.**

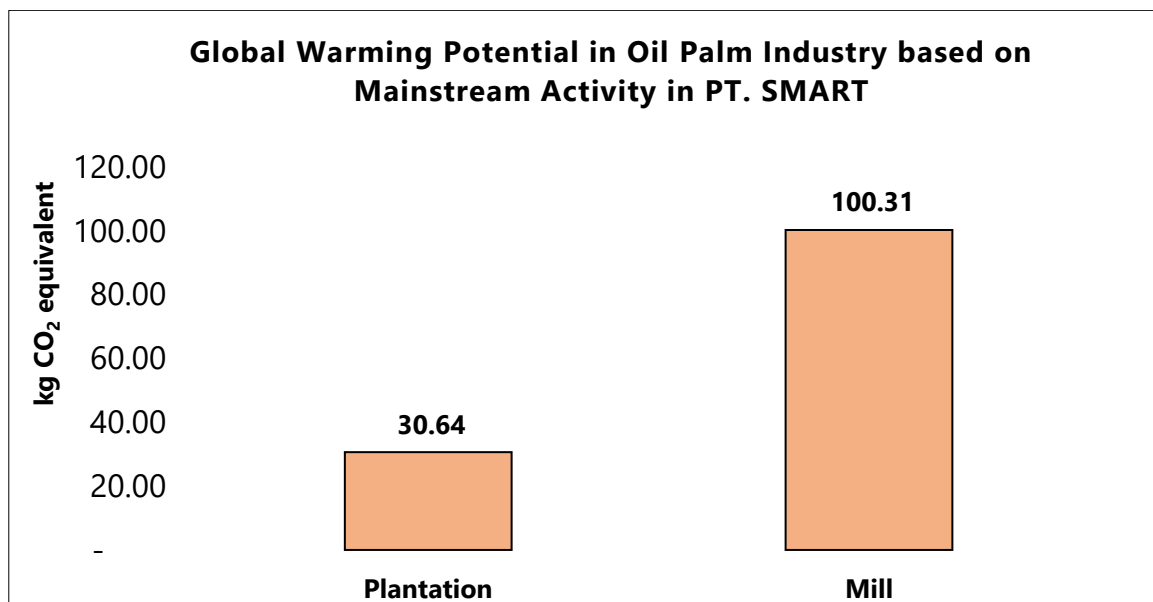

*Figure 19 GWP of Oil Palm Plantation and Mill Value Change in PT. SMART – Calculated Manually from Foreground Data Without Consideration to LULUC*

About 41% plantation in Indonesia belongs to smallholder who do not have capacity to process their fruit bunch. Distance between smallholders' plant to the mill in average is 50-60 km, therefore transportation of fruit bunch to the mill also contributes to a significant number of CO<sub>2</sub> emission. The concept of mill with large production capacity should be shifted to decentralization of palm oil processing mill facilities (max. 20 km from the plantation). Smallholders could be potential partners to build the facilities.

Hitherto, the mill industry still adopts the European sterilization concept (wet process), utilizing steam (which is energy extensive) and generating liquid waste (source of emission). Dry process (steamless palm oil processing) potentially reduces 18% of current production cost of CPO using wet process. Smallholders' involvement in decentralization of mill facility and transformation from wet to dry process could reduce emission as well as production cost and alleviate poverty.



### 3.3 Refinery Value Chain

The palm oil refinery considers degumming, bleaching, deacidification, deodorization, and fractionation of CPO into 4.5% palm fatty acid distillates (PFAD), 71.6% refined palm olein (RPO i.e., cooking oil) and 23.9% refined palm stearin (RPOs). For refinery, the emissions come from steam and energy generation, the use of phosphoric acid and bleaching earth, as well as transportation of CPO and chemicals. Figure 20 shows the flow chart for palm oil refinery.

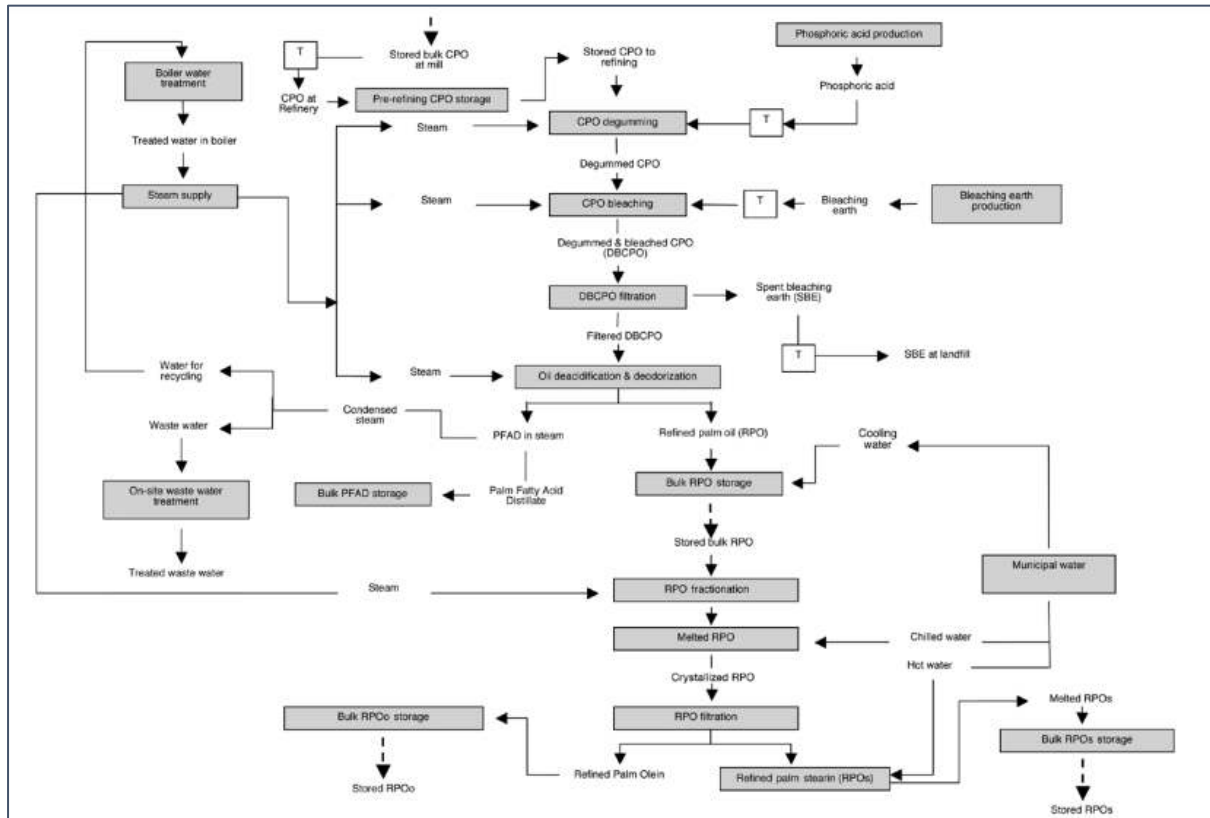

Figure 20 Flow Chart for Palm Oil Refinery<sup>24</sup>

Figure 21 and Figure 22 show the network assessment of palm oil refinery for scenarios 1 and 2, respectively. Mill and Plantation actions are responsible for 1005.7 kg CO<sub>2</sub>-eq/100 kg produced CPO (99.5%wt of total CO<sub>2</sub> emission from the refinery scenario 1). Refinery process itself only contributes to 5.05 kg CO<sub>2</sub>-eq/100 kg produced CPO that comprises of contribution from steam and energy generation (42.9%), bleaching earth production (30.7%), and transportation (25.1%).

<sup>24</sup> Yewai, et al. (2010) Journal of Oil Palm Research 22:913-926.

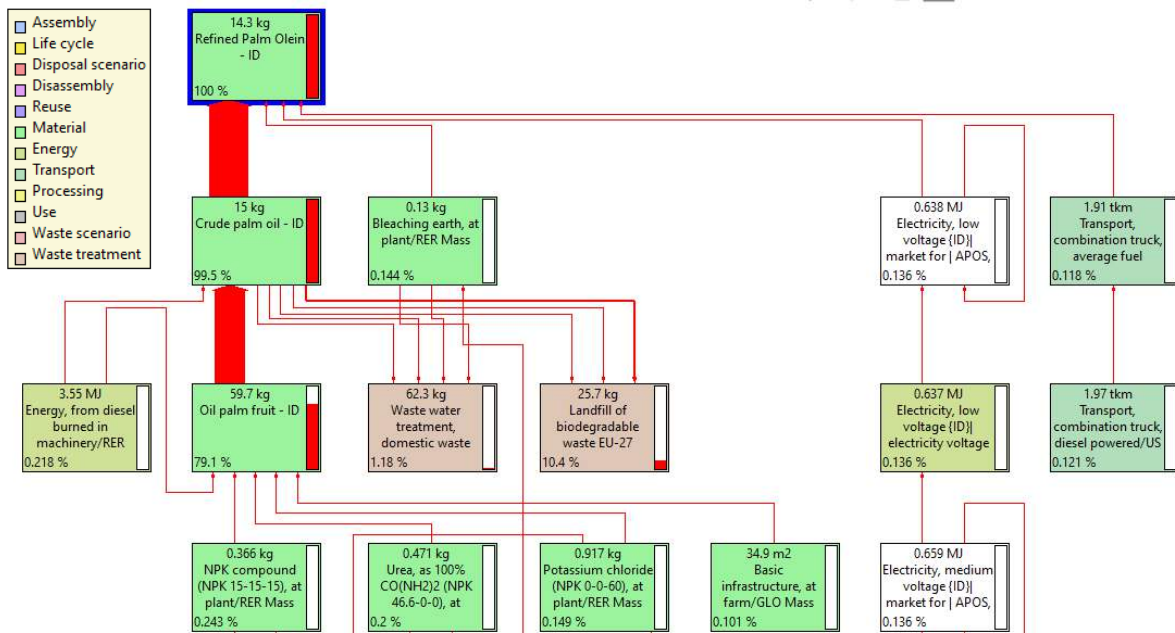

Figure 21 Network Assessment of the Refinery Scenario 1 (Background Data with LULUC)

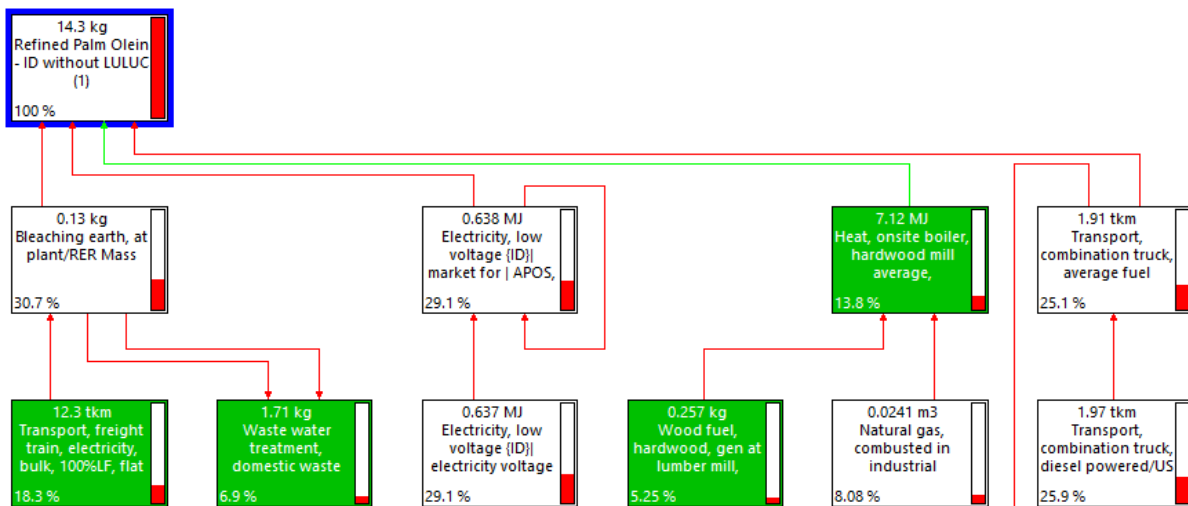
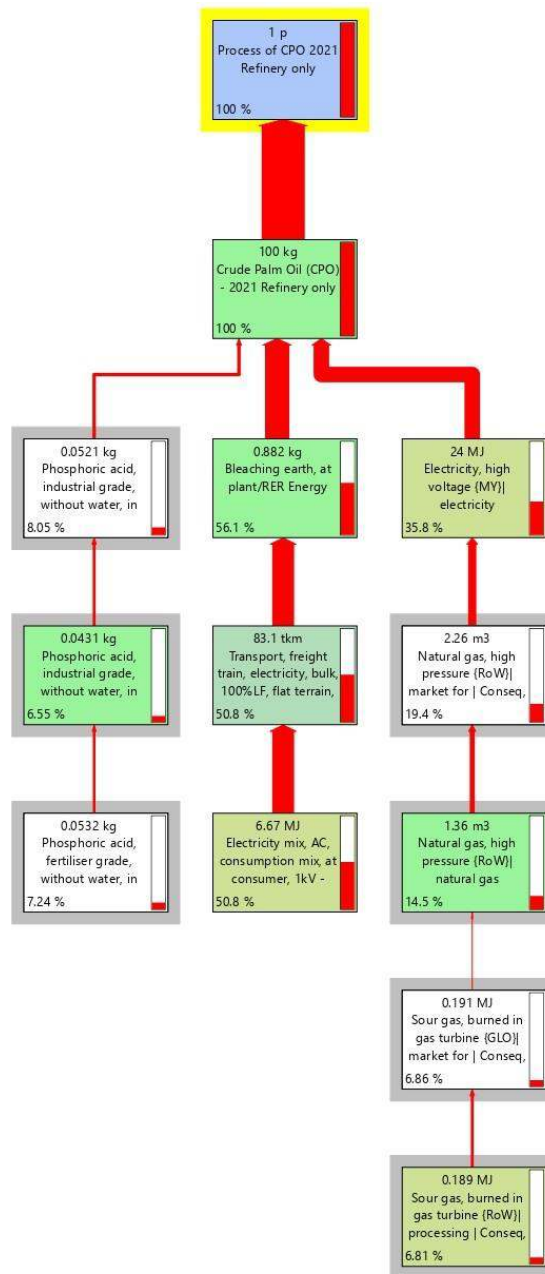

Figure 22 Network Assessment of the Refinery Scenario 2 (Background Data Without LULUC)

The data for calculating Life Cycle Impact Assessment in this chain used primary data from PT. SMART with using software (scenario #3). The flow chart for palm oil refinery can be seen in Figure 20. Based on observation of foreground data from PT. SMART, the result showed that refinery produced a lowest contribution impact of Global Warming Potential (GWP) than palm plantation and mill value.

The inventory data for refinery includes input are chemicals, electricity used and heat. Meanwhile, output data for this process are emission and wastewater. The chemicals used for this process are Phosphoric acid, Bleaching earth and Citric acid. Figure 21 shows the network assessment of refinery scenarios.



**Figure 21 Network Assessment of the Refinery Scenario in 2021 (Background Data Without LULUC)**

The CO<sub>2</sub> equivalent is calculated by software with a functional unit of 100 kg CPO, it is found that refinery contributes for 6.69 kg CO<sub>2</sub> eq emissions. On the other hand, this chain also produced another impact, such Acidification, Eutrophication, Abiotic Depletion and Water Toxicity. However, the impact of GWP is one of the highest impacts from this chain. Based on impact assessment by using EPD (2018) V1.01 method on Simapro, refinery becomes the lowest contribution for GWP concentration. It caused the total of chemicals used in this chain to only amount 0.935 kg for 100 kg CPO production.

In this chain, chemicals used do not need a large amount than palm plantation and mill value for 100 kg CPO production. PT. SMART has 3 (three) sub processes of refinery, including (i) Degumming, (ii) Bleaching and (iii) Deodorizing. Degumming is a purification process to separate the sap and mucus in the oil without reducing the amount of free fatty acids in the

oil. Generally, degumming only needs water and acid in the process, such as sodium chloride, phosphoric acid, citric acid and sulphate acid. Based on the data PT. SMART, degumming process used citric acid ( $C_6H_8O_7$ ) and water for separate the sap and mucus by heating. However, if citric acid reacts with water,  $CO_2$  becomes one of the products from the reaction. On the other hand,  $CO_2$  is one of the emissions that contributed to GWP. Phosphoric acid is also used in the degumming process. The second process is bleaching. Bleaching aims to separate dyes and organic substances in palm oil by using an adsorbent. The third process is deodorizing. Deodorizing is processed to evaporate the compounds cause of odor in palm oil. The principle of this process is distillation of palm oil with heat and atmospheric pressure. Basically, bleaching and deodorizing process is used combustion reaction, where in general all the combustion reaction will produce carbon to atmosphere. Based on GWP specification for substance in Simapro, the result showed that carbon monoxide became the highest compartment affecting global warming. Carbon monoxide contributed 1.31 kg  $CO_2$  eq emission from total concentration GWP for 6.69 kg  $CO_2$  eq emissions. Highest contribution carbon monoxide to atmosphere eventually global warming. **Thus, the software calculation of background data and foreground data from PT. SMART shows that refineries make the lowest contribution of GWP than palm plantation and mill value chains.**

### 3.4 Packaging and Distribution Value Chain

Palm cooking oil packaging available in several forms, such as HDPE jerrycan, PET bottle, standing pouch, plastic glass, sachet, etc. (see Figure 23). Specifications of each packaging are shown in Table 4. The aim is to evaluate the waste and  $CO_2$  contribution of packaging in every kg of palm cooking oil production. Based on the criteria of resource reservation, complexity of production process, and sales, 2 L bottle packaging contributes the highest value, followed by 1 L polyolefin pouch and 60 mL BOPP economical sachet packaging. Therefore, for the sake of this study, comparison between the three packaging sizes have been conducted. Functional unit of 14.3 kg cooking oil is used for the calculation. Table 5 comprises the inventory databases used in the impact assessment of global warming as well as water consumption.



Figure 23 Palm Cooking Oil Packaging

**Table 4 Plastic Packaging Form for Palm Cooking Oil**

Packaging type	Material	Volume	Weight	Lifetime
Sachet	BOPP	60 mL	2 g	Single-use
Glass	PET	150 mL	8 g	Single-use
Standing pouch	Polyolefin	1000 mL	18g	Single-use
Bottle	PET & PP	2000 mL	86 g & 2 g	Single-use
Jerrycan	HDPE	5000 mL	200 g	

**Table 5 Inventory database for PET bottle, Polyolefin pouch, and BOPP sachet packaging**

Parameter	Notasi	Bottle	Pouch	Sachet
Refined Palm Olein	<b>A</b>	1.82 kg	0.91 kg	0.056 kg
Polyethylene terephthalate, granulate, bottle (GLO)} market, APOS, U	<b>B</b>	86 g	0	0
Polypropylene, granulate (GLO) market, APOS, U	<b>C</b>	2 g	18 g	2 g
Transport, freight, lorry 16-32 metric ton, EURO5 (RoW) APOS, U	<b>D</b>	0.2 tkm	0.1 tkm	0.006 tkm
Extrusion of plastic sheets and thermoforming, inline (GLO) APOS, U	<b>E</b>	88 g	18 g	2 g

Indonesian population distributions are shown in Figure 24. Similar to the palm oil refinery profile. The population is concentrated in Java and Sumatra Island. Therefore, the study focused on Jakarta as the capital of the country with most of the population as well as refinery could be zoomed in as a representative case study.

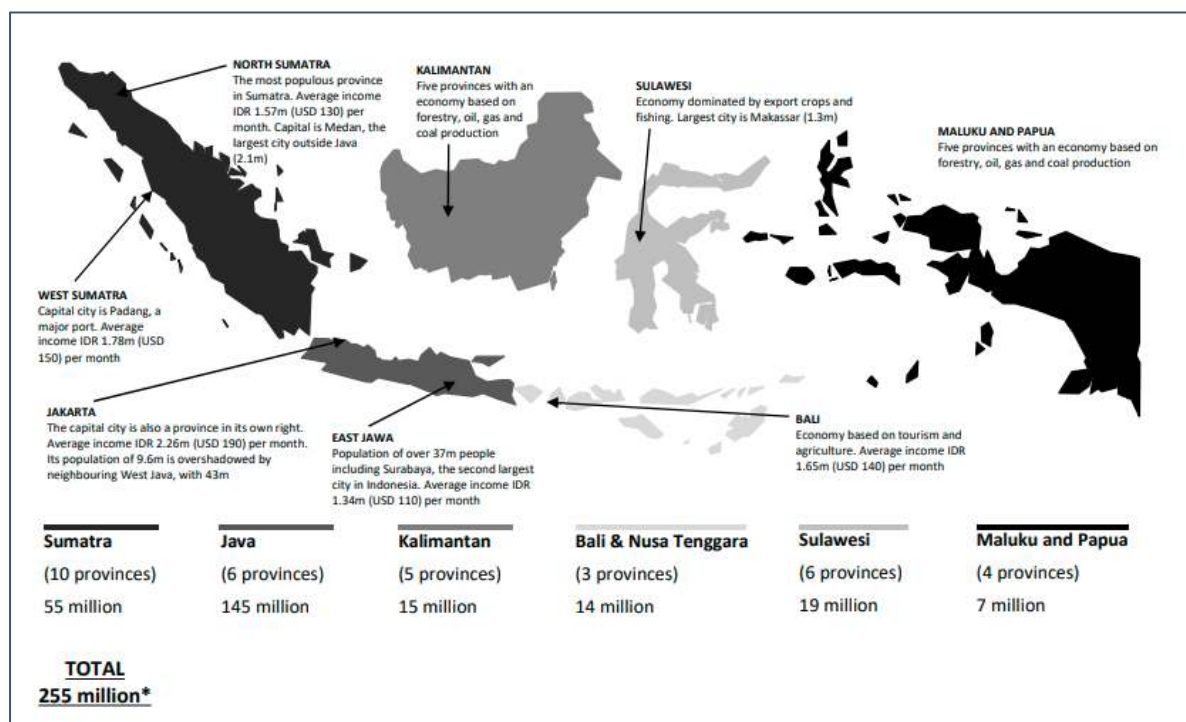

**Figure 24 Indonesian Population Distributions**

Figure 25 depicts Palm Cooking Oil Distribution Map (top) as well as Stakeholders (bottom) – Case Jakarta. Jakarta is chosen as representatives due to the population (market) and the data accessibility of mill and refinery transportation distance.

With the assumption that the packaged palm cooking oil is distributed using a Freight lorry 16-32t, with an average distribution distance = 100 km, the global warming potentials that come from the palm cooking oil packaging and distributions are 3.75, 1.95, and 2.78 kg CO<sub>2</sub>/100 kg CPO for bottle, pouch, and sachet, respectively. CO<sub>2</sub> emissions (Figure 26) come from refined palm olein (19-36.5%), plastic resources (34.3-54.5%), transportation (7.4-14%) and electrical energy (15.3-19.9%).

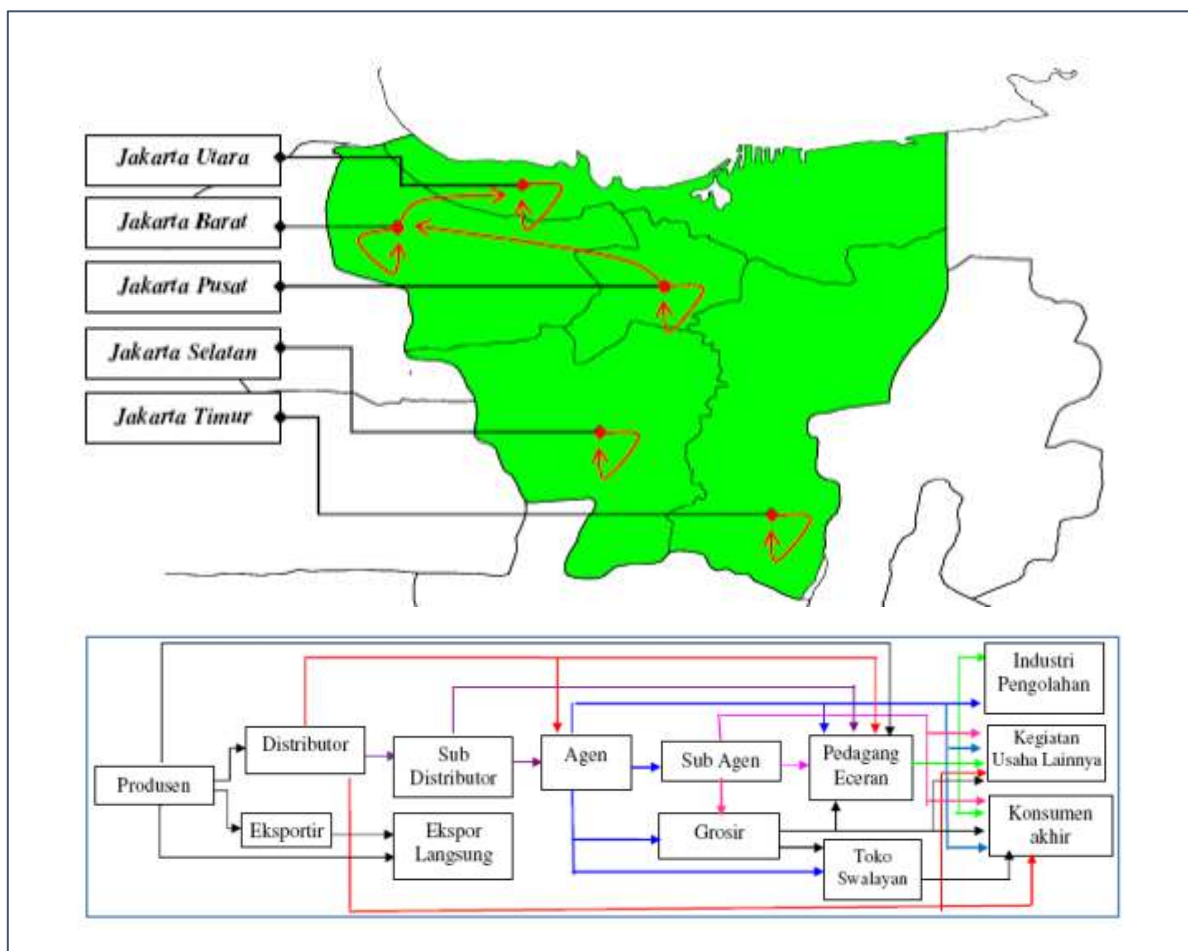

**Figure 25 Palm Cooking Oil Distribution Map (top) as well as Stakeholders (bottom) – Case Jakarta**

## CO<sub>2</sub> Emission in Packaging & Transportation

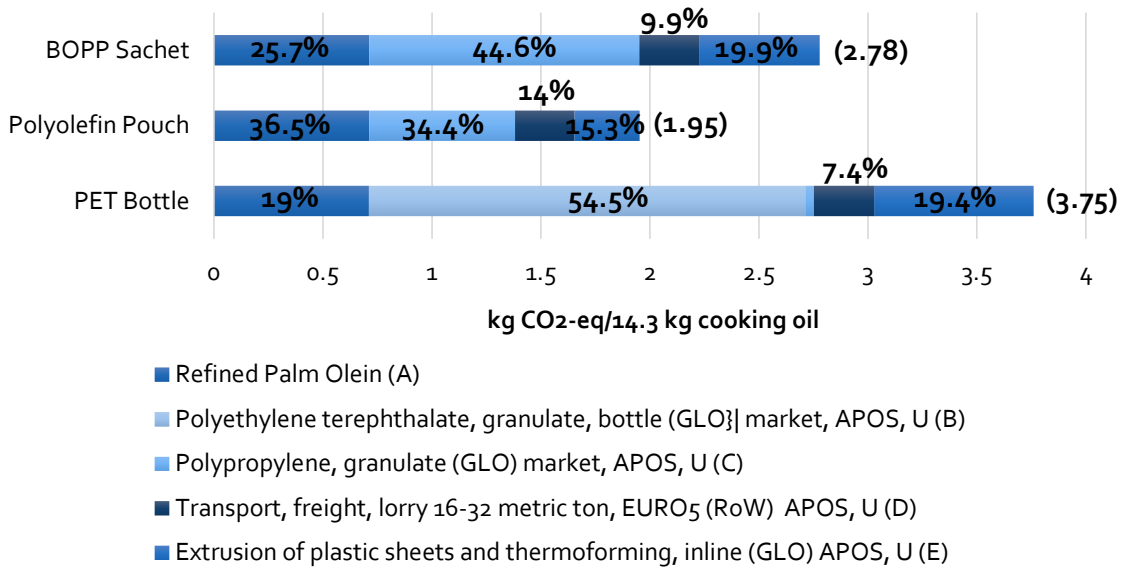

Figure 26 Analysis of Package Cooking Oil with (top) and without (bottom) LULUC

### 3.5 Consumption and Disposal Value Chain

The consumption of vegetable cooking oil can be considered carbon neutral. Meaning CO<sub>2</sub> released when it burned is the same as CO<sub>2</sub> taken by the plant to grow. Indonesian cooking oil consumption per capita in 2022 is projected to approximately be 6 MMt (6.6 MM<sup>3</sup>). Through purification, refinement, and transesterification, 1.64 MM<sup>3</sup>/year used in cooking oils could produce 1.23 MM<sup>3</sup> (35% of yearly biodiesel demand), reduce 6 MT GHG, save 1.16 MT CPO/year, and save 321 thousand ha forestation. Besides, the used cooking oil could cause a lot of environmental issues. It hardens and infiltrates into a local sewer, water and waste management facilities when it is poured down the drain. When tossed in the trash or carelessly littered in the dirt or grass outside, fats, oils, and greases seep into our ecosystems and affect our food supply.

In the production of palm cooking oil (RPO olein), the impacts are mainly associated with upstream activities at the oil palm plantation and the palm oil mill. The upstream impacts resulting from FFB and CPO production are propagated down to the production of RPO/RPOo/RPOs, while the refinery activities confined to the production of RPO, RPOo, and RPOs as well as packaging and distributions are found to have minor impacts on the environment in comparison. The consumptions are considered neutral in carbon emission; thus, the approach has been made through its utilization as a raw material for biodiesel production to support B30. The main contributor to the fossil fuels category is the production and use of fertilizers for the cultivation of oil palm, with minor inputs from the refining and fractionation processes through the transport of raw and waste material and distribution of products, as well as the use of boiler fuel. The hotspots in relation to respiratory inorganics and climate change are mainly from upstream activities, e.g., the application of nitrogen fertilizers for the cultivation of the palms, and the emissions of methane as well as carbon dioxide from the landfill of biodegradable waste activity and POME ponds at the mill.

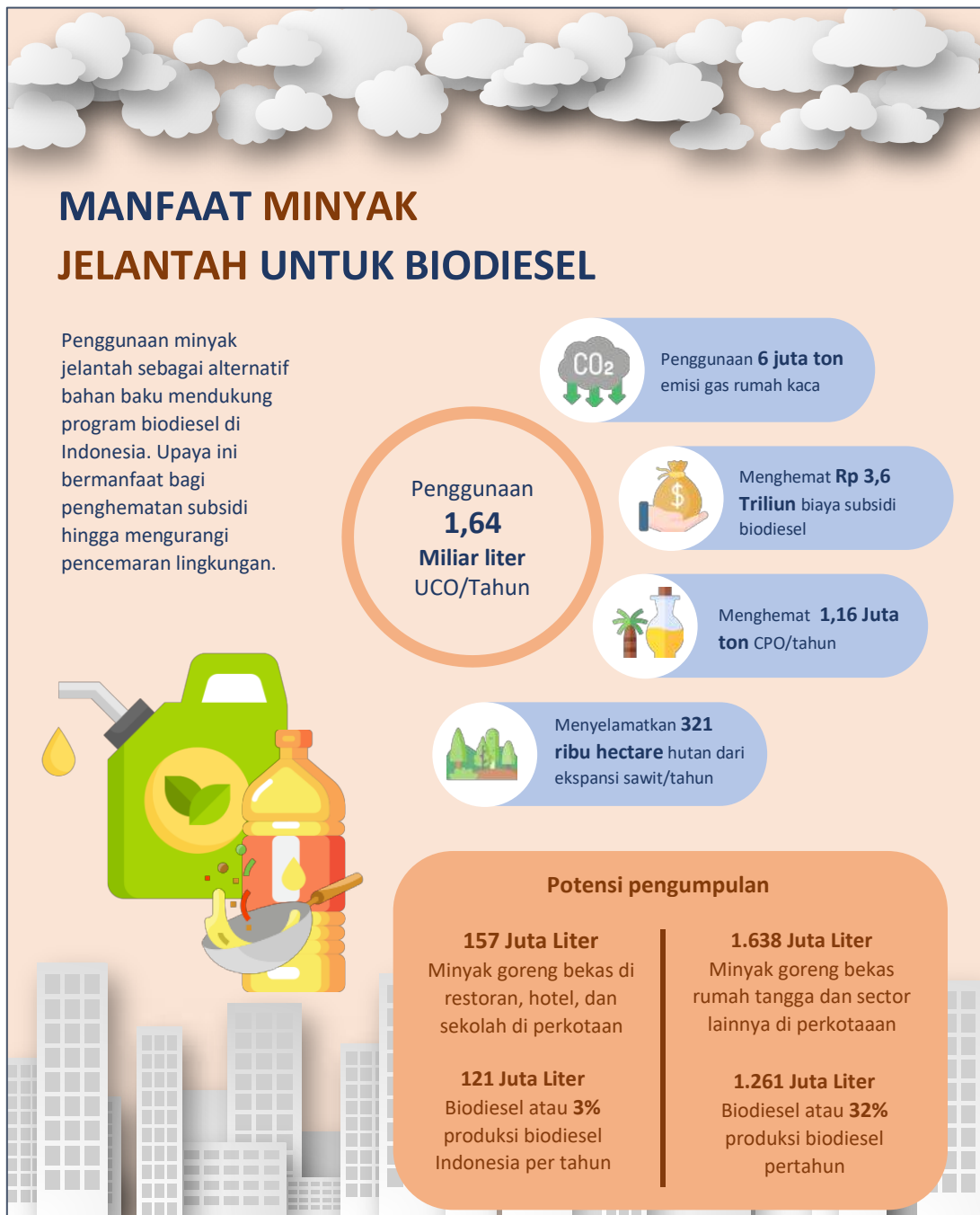

Figure 27 The Potential of Incorporating Used Cooking Oil into Indonesia's Biodiesel <sup>25</sup>



<sup>25</sup> Katadata.co.id, 2020. *Manfaat Minyak Jelantah untuk Biodiesel*; based on: ICCT, 2018. *The Potential Economic, Health, and Greenhouse Gas Benefits of Incorporating Used Cooking Oil into Indonesia's Biodiesel*.



## 4. Sociotechnical Options of Waste and CO<sub>2</sub> Reduction Strategies

There are several mitigation strategies for POME treatment that have been developed by PTPN V in collaboration with ITB:

### 1) Conversion of POME into biogas for electricity production

Palm oil mills produce liquid waste known as palm oil mill effluent (POME) in the production process of crude palm oil (CPO). POME is wastewater produced by palm oil mills, mainly from boiled condensate, hydro cyclone water, and sludge separator. The Decree of the State Minister of the Environment Number 28/2003 regulates the quality standards for POME applications on the land. POME characteristics and environmental quality standards are shown in Table 6.

*Table 6 Characteristics and Environmental Quality Standards of POME*

Parameter	Unit	Unprocessed POME		Quality standards	
		Interval*	Average	River**	Land Application
BOD	mg/L	8,200-35,000	21,280	100	
COD	mg/L	15,103-65,100	34,370	350	
TSS	mg/L	1,330-50,700	31,170	250	
Ammonia	mg/L	12-126	41	50***	
Oil and fat	mg/L	190-14,720	3,075	25	
pH		3.3-4.6	4	6-9	6-9
Maximum of POME generated	m <sup>3</sup> /ton CPO			2.5	

\* Palm Oil Industry Waste Management Guidelines, 2006 Ministry of Agriculture, Ministry of Environment Regulation No. 3 of 2010

\*\* Minister of Environment Decree No. 51/1996

\*\*\* Total nitrogen = organic nitrogen + total ammonia + NO<sub>3</sub> + NO<sub>2</sub>

2.5-3 m<sup>3</sup> of POME is produced for every ton of CPO production. Thus, POME needs to be processed since it contains organic carbon with a COD value of more than 40 g/L and nitrogen content of around 0.2 and 0.5 g/L as ammonia nitrogen and total nitrogen. One potential alternative to improve POME management in this mill is to process POME into biogas in an anaerobic pond. The decomposition of organic waste (POME) into biogas utilizes microorganisms, producing biogas and residue that can be used as fertilizer. In this process, POME (organic waste) serves as a substrate or growing medium for organisms. This process has two main advantages: the biogas produced from the degradation process can be utilized and has economic value. In addition, PKS can treat waste to avoid negative environmental impacts and comply with regulations safely and quickly. Biogas generally contains 60% methane (CH<sub>4</sub>) and 40% carbon dioxide (CO<sub>2</sub>). Therefore, a palm oil mill with a processing capacity of 60 tons per hour of fresh oil palm fruit bunches, such as the Terantam Palm Oil Mill in Riau, has the

potential to produce POME, which can be processed into biogas for power plants with a power of about 2 MW.<sup>26</sup> Implementing POME to biogas conversion technology for electricity can reduce the GHG emission of up to 70,000 tons of CO<sub>2</sub>-eq per year.<sup>25</sup>



**Figure 28 Schematic Illustration of POME Conversion to Biogas for Electricity Production** <sup>27</sup>

## 2) Conversion of POME into biomethane for fuel of palm oil plantation trucks

Biogas can be purified into biomethane through CO<sub>2</sub> separation technology. This purification is carried out to increase the added value of the resulting fuel, converted into vehicle fuel (BBG). The potential process technology for purifying biogas into biomethane in this mill is CO<sub>2</sub> absorption with water (water scrubbing). This technology is relatively simple and economical compared to other CO<sub>2</sub> separation technologies. Moreover, it only requires processed water as a working fluid, making it suitable for application in rural areas or oil palm plantations. This technology has also been proven because it has been used in other applications (non-biogas) for decades.

The collaboration between the Department of Chemical Engineering ITB, BPPT (BRIN), PTPN V, BDPKS, and Aintop Indo Nuansa Kimia has successfully implemented the demonstration of biogas purification technology into biomethane for gas fuel via CO<sub>2</sub> absorption with water. From November to December 2021, CNG converter trucks carried out biomethane product testing. Biomethane is put into a tube up to a pressure of 200 bar, which is used as fuel for vehicles/trucks with a gas converter installed in the combustion system. Trucks with biomethane fuel were tested in plantation areas and roads with a total distance of 250 km without problems, with an average CNG consumption of 3.4-3.5 kilometers per Liter of Premium Equivalent (LSP) with a load-carrying condition of 5-6 tons. The results of this study represent a breakthrough in the utilization of POME produced by Palm Oil Mills, which can be used as a renewable energy source and simultaneously reduce greenhouse gas emissions. The resulting CNG can be used as fuel for oil palm plantation trucks by installing a gas converter like CNG from natural gas. A palm oil mill with a capacity of 60 tons/hour has the potential to produce 600 Nm<sup>3</sup>/hour of biogas, which can be processed into 360 Nm<sup>3</sup>/hour of biomethane, which is equivalent to 8,350 LSP/day.<sup>28</sup> Implementing POME to

<sup>26</sup> BPPT, 2019. *PLT Biogas POME, Olah Limbah Cair Sawit Menjadi Listrik*. <https://bppt.go.id/berita-bppt/plt-biogas-pome-olah-limbah-cair-sawit-menjadi-listrik>.

<sup>27</sup> Raksajati, 2020.

<sup>28</sup> BDPKS, 2021. *ITB Berhasil Mendemonstrasikan Pemurnian Biogas Menjadi Biometana Untuk Bahan Bakar Gas (BBG)*. <https://www.bdp.or.id/itb-berhasil-mendemonstrasikan-pemurnian-biogas-menjadi-biometana-untuk-bahan-bakar-gas-bbg>

biomethane conversion technology can reduce the GHG emission of up to 30,000 tons of CO<sub>2</sub>-eq per year.



**Figure 29 Schematic Illustration of POME Conversion to Biomethane for Fuel of Palm Oil Plantation Trucks<sup>29</sup>**

Other product Improvements specifically to reduce emissions from fertilizers:

**1) Precision agriculture in fertilizing**

The current fertilization recommendation must refer to the needs of the plant so that the dose given tends to be optimum and reduces the conditions where fertilizer is excessive and causes environmental damage such as high emissions, decreasing soil health, and causes damage to the aquatic environment. In addition, fertilization recommendations can refer to the analysis of plant (Leaf sampling Unit) and soil health (Soil Sampling unit), where leaf and soil samples are taken periodically so that dosing will be more accurate and precise.



**Figure 30 Leaf Sampling Unit**



**Figure 31 Soil Sampling Unit**

<sup>29</sup> Raksajati, 2020.

## 2) Optimization of by-product utilization

The oil palm plantation industry is efforting to reduce the potential for contamination, and environmental damage is applied to the concept of zero waste. Therefore, all palm oil waste products can be utilized and have a favorable economic value. In this case, solid waste, including Empty Fruit Bunch (EFB), can be used as a source of organic fertilizer to the planting area, either given directly or composted first. Every ton EFB substitute inorganic fertilizer is equivalent to 3,8 kg Urea; 3,9 kg RP; 18,0 kg KCL; and 9,2 kg Kieserite (Mannan, 2014). Another product, including palm oil mill effluent (POME), can be channeled into plantation areas as a source of liquid organic fertilizer; of course, before being channeled, it must be processed first until it reaches quality standards. Every m<sup>3</sup> POME substitute inorganic fertilizer is equivalent to 1,5 kg Urea; 0,3 kg RP; 3,0 kg KCL; and 1,2 kg Kieserite (Elfidiah, 2012). During the processing, several industries build methane capture installations which will later be used as raw material for methane-powered power plants (Biogas). Other wastes, such as fiber, are generally composted or used for combustion in boiler furnaces. In contrast, palm kernel shells are used as plant mulch, road pavers, and boilers waiting for raw materials. Overall, utilization of by-products, especially for organic fertilizers, can contribute to substituting the inorganic fertilizer and also increase soil health. Finally, the industry will save the cost, especially from fertilizer purchasing and implementing the circular economy, and apply the sustainability of oil palm practice.



*Figure 32 Palm Oil Mill Effluent for Organic Liquid Fertilizers*



*Figure 33 Direct EFB Utilization (left) and Composting (right)*

### 3) Legume cover crops optimizing

Soil health is one of the most critical factors in improving plant health and increasing productivity. Soil health includes optimum and mutually supportive physical, chemical, and biological properties of the soil. One way to maintain soil health needs to be maintained by minimizing the use of chemical fertilizers. There is one cultivation technique (technical culture) in utilizing several biological agents that can naturally supply several essential elements for plants, one of which is by utilizing legume cover crops. Legume covers crops that store nitrogen in nodules on the roots. The plant harvests nitrogen gas from the air and combines it with hydrogen. The process creates ammonia, which is converted by bacteria into nitrates, a usable form of nitrogen. Legumes on their own can offer many benefits, including fixing atmospheric nitrogen, providing a nitrogen source for the soil to be used by future crops, as well as protection from soil erosion along with building soil structure and organic matter. Legume cover crops can provide over 150 kg N/ha (Zablotowicz, et.al., 2011).



*Figure 34 Legume Cover Crops in Oil Palm Plantation*

















**4) Facilities Decentralization, Smallholders Support, Collaboration, and Empowerment**

Smallholders hold 41% palm oil plantation, and they must be supported in processing their fruit bunch. The current distance from smallholders' plantation field to the nearby mills is about 50-60 km and transportation becomes a burden that not only increases the production cost, but also increases the GWP from transportation activities. Decentralized milling facilities to max 20 km distance by empowering smallholders to the owner as well as the worker of the facilities could be a way out to lower the emission and cost, as well as alleviation of poverty.

**5) Development of dry process-based technology "Steamless Palm Oil Technology (SPOT)"**

Nusantara Green Energy (NGE) has developed Steamless Palm Oil Refinery in Jambi. The process could eliminate palm oil mill effluent, reduce the energy requirement, as well as improve nutritional content of the product. No refinery needed, the palm oil could go straight to the market as table oil and palatable food. Reductions from POME as well as refinery side have the potential to reduce emissions by about 80%. Detailed process could be available after discussion with NGE.

# Conclusions and Recommendations

Life Cycle Analysis (LCA) & Waste and CO <sub>2</sub> Reduction (WCR) in Palm Cooking Oil Industry to create Circular Economy					
	 Plantation & Cultivation <sup>a</sup>	 Mills <sup>a</sup>	 Refinery <sup>b</sup>	 Packaging & Distribution <sup>b</sup>	 Use & Disposal
	28.7 (kg CO <sub>2</sub> -eq)	207 (kg CO <sub>2</sub> -eq)	6 (kg CO <sub>2</sub> -eq)	(in kg CO <sub>2</sub> -eq) PET Bottle: 3.75 PP Pouch: 1.95 BOPP Sachet: 2.78	With assumption, the use of 25% used cooking oil can replace 35% of national biodiesel <b>demand</b>
	<b>Chemical fertilizer: 90.8%</b> Energy & Machinery: 3.77% Infrastructure: 3.56	<b>Landfill solid waste: 44.9%</b> Wastewater treatment: 4.9% Energy & Machinery: 0.9%	<b>Chemicals: 79.1%</b> Landfill of waste: 10.4% Wastewater treatment: 1.18% Energy & machinery: 0.22%	<b>Plastic resources: 34.4-54.5%</b> RPO: 19-36.5% Energy: 15.3-20% Transportation: 7.4-14 %	 Use of 6 million tons of greenhouse gas emissions
	Electricity: 21.04 x 10 <sup>-3</sup> kWh Solar: 0.54 x 10 <sup>-3</sup> L AFP Fuel: 11.6 MJ	Electricity: 22.68 x 10 <sup>-3</sup> kWh Solar: 1.51 x 10 <sup>-3</sup> L AFP Electricity: 0.11 kWh AFP Fuel: 23.6 MJ	Electricity: 18.3 x 10 <sup>-3</sup> kWh Solar: 0.81 x 10 <sup>-3</sup> L AFP Electricity: 0.43 kWh AFP Fuel: 9.54 MJ	Electricity: 0.38-1.28 kWh Solar: 0.067-0.083 L	 Save IDR 3.6 Trillion on biodiesel subsidy costs
	4.34 X 10 <sup>-3</sup> m <sup>3</sup> AFP database: 0 m <sup>3</sup>	2.1 X 10 <sup>-3</sup> m <sup>3</sup> AFP database: 350 L	0.14 X 10 <sup>-3</sup> m <sup>3</sup> AFP database: 3.8 L	PET Bottle: 19.6 L PP Pouch: 16.7 L BOPP Sachet: 31 L	 Save 1.16 Million tons of CPO/year
	292 g	1470 g AFP solid waste: 215kg AFP liquid waste: 507.5 kg	5.7 g AFP solid waste: 222 g AFP liquid waste: 843 L	<sup>d</sup> PET Bottle: 218.4 g PP Pouch: 282.9 g BOPP Sachet: 523.8 g	 Save 321 thousand hectares of forest from oil palm expansion/year
<sup>a</sup> Basis of 100 kg CPO production; <sup>b</sup> Basis of 14.3 kg cooking oil; <sup>c</sup> Distance assumption of 100 km; <sup>d</sup> PET %-recycle assumption of 70%					
Recommendation					
	Encouragement of Downstream Palm Oil Industry			Utilization of used cooking oil for national biodiesel production	
	Conversion & Utilization of solid waste & POME into organic fertilizers	Improve chemical usage efficiency.	Recycling of PP & PET		
	Advancing cultivation technique (Precision Fertilizer, Legume Optimizer, water & pest management)	Optimization of bleaching process.	Development of eco and biodegradable packaging		
	Combining chemical and biological methods for wastewater treatment  Byproduct utilization: -Briquetting solid waste (palm kernel, shell, and fiber) for biomass fuel (biofuel) -Methane capture  Use of Steamless Palm Oil Technology (SPOT)	Use of dry process to reduce "liquid"-based waste  Decentralization of refinery facility			
	Smallholders empowerment through decentralized palm oil processing facilities → community building & poverty alleviation				

## References

- Blonk Agri-footprint BV. (2019). Agri-footprint - Part 1 - Methodology and basic principles. Gouda, the Netherlands.
- Blonk Agri-footprint BV. (2019). Agri-footprint - Part 2 - Description of data. Gouda, the Netherlands.
- Blonk Consultants. (2018). The Direct Land Use Change Assessment Tool. Gouda.
- Delahaye, R. Fong, P. Van Eerdt, M. (2003). Emissie van zeven zware metalen naar landbouwgronden.
- Elfidiah, Dedik, B., Faizal., Salni. (2012). Organic liquid fertilizer from palm oil mill effluent (POME) enriched by indigenous bacteria activator. Technology, science, social sciences and humanities international conference.
- EMEP/EEA (2016). EMEP/EEA air pollutant emission inventory guidebook 2016, volume 3: Crop production and agricultural soils.
- FAO (2019). FAOstat crop statistics, retrieved from: [faostat.fao.org](http://faostat.fao.org).
- FAO (2019). FAOstat manure management statistics, retrieved from: [faostat.fao.org](http://faostat.fao.org).
- Hashim K, Tahiruddin S, Asis AJ (2012) Palm and Palm Kernel Oil Production and Processing in Malaysia and Indonesia. Palm Oil, 235-250.
- IFA (2011). Personal communication. Director Agriculture and Environment, Fertilisers Europe, Brussels.
- IFA (2019). Statistical Information, retrieved from: [ifadata.fertilizer.org](http://ifadata.fertilizer.org).
- IPCC (2006). 2006 IPCC Guidelines for National Greenhouse Gas Inventories, volume 4: Agriculture, Forestry and Other Land Use.
- Mannan, A. (2014). Empty Fruit Bunch. [Empty fruit bunches \(EFB\) \(etawau.com\)](http://etawau.com) (Accessed 14 July 2022).
- Mekonnen, M. M., & Hoekstra, A. Y. (2010). The green, blue and grey water footprint of crops and derived crop products - Volume 1: Main Report (Vol. 1).
- Mels, A., Bisschops, I., & Swart, B. (2008). Zware metalen in meststoffen - vergelijking van urine en zwart water met in Nederland toegepaste meststoffen.
- Mengqing Kan and Shelie A. Miller. Environmental impacts of plastic packaging of food products. Resources, Conservation & Recycling 180 (2022) 106156.
- Nemecek & Schnetzer (2012). Methods of assessment of direct field emissions for LCIs of agricultural production systems.
- P. Tsarouhas, Ch. Achillas, D. Aidonis, D. Folinas, V. Maslis. Life Cycle Assessment of olive oil production in Greece. Journal of Cleaner Production 93 (2015) 75-83.



- PAS 2050-1 (2012). Assessment of life cycle greenhouse gas emissions from horticultural products.
- ReCiPe (2013). ReCiPe 2008 a life cycle impact assessment method which comprises harmonised category indicators at midpoint and endpoint level - revised.
- Sovacool BK, Bazilian M, Griffiths S, Kim J, Foley A, Rooney D (2021) Decarbonizing the food and beverages industry: A critical and systematic review of developments, sociotechnical systems and policy options. *Renewable and Sustainable Energy Reviews*, 143, 10856.
- Tan YA, Halimah M, Zulkifli H, Subramaniam V, Puah CW, Chong CL, Ma AN, Choo YM (2010) Life cycle assessment of refined palm oil production and fractionation (Part 4). *Journal of Oil Palm Research*, 22, 913-926.
- Vergheze K, Lockrey S, Clune S, Sivaraman D (2012) Life cycle assessment (LCA) of food and beverage packaging. *Emerging Food Packaging Technologies* Ch. 19, 380-408.
- Vellinga, T. V., Blonk, H., Marinussen, M., Zeist, W. J. Van, Boer, I. J. M. De, & Starman, D. (2013). Methodology used in feedprint: a tool quantifying greenhouse gas emissions of feed production and utilization.
- Zablotowicz, R.M., Reddy, K.N., Krutz, L.J. (2011). Can Leguminous Cover Crops Partially Replace Nitrogen Fertilization in Mississippi Delta Cotton Production?. *International Journal of Agronomy*, 9, 4.



## Appendix 1: System Boundaries for LCA Analysis

### SEEDLING

<b>Processing Category</b>	<b>Included</b>	<b>Excluded</b>
<i>Production of polyvinylchloride for pipes</i>	v	
<i>Production, maintenance, and replacement of capital equipment</i>		v
<i>Transportation of capital goods</i>		v
<i>Production of agricultural inputs, e.g., polybags, fertilizers, insecticides, herbicides and fungicides</i>	v	
<i>Disposal of small polybags (15 cm × 23 cm)</i>		v
<i>Transportation of polybags, fertilizers, insecticides, herbicides and fungicides</i>	v	
<i>Water supply</i>	v	
<i>Agricultural activities, e.g. application of fertilizers, insecticides, herbicides and fungicides; use of polybags</i>	v	
<i>Transportation of germinated seeds to nursery</i>	v	
<i>Land occupation by nursery</i>		v
<i>Transportation of seedlings to plantation</i>	v	
<i>Electricity generation</i>	v	
<i>Diesel for running water pump</i>	v	
<i>Production of top soil</i>		v
<i>Partitioning of pesticides in different compartments</i>	v	
<i>Emissions from the application of pesticides</i>	v	

### PLANTATION

<b>Processing Category</b>	<b>Included</b>	<b>Excluded</b>
<i>Production, maintenance, and replacement of capital equipment</i>		v
<i>Production of kieserite fertilizer, borate fertilizer, NPK compound fertilizer</i>		v
<i>Indirect land use change</i>		v
<i>Disposal of polybags at the plantation</i>		v
<i>Production of urea</i>	v	
<i>Production of ammonium sulphate</i>	v	
<i>Production of phosphate rock</i>	v	
<i>Production of muriate of potash</i>	v	
<i>Impact of heavy metals to the environment</i>		v
<i>Usage of pesticides</i>	v	
<i>Capital goods</i>	v	
<i>Production of plantation pesticides</i>	v	
<i>Transportation of raw materials from the port to plantation</i>	v	
<i>Transportation of FFB to mill</i>	v	
<i>Plantation input e.g. fertilizers and pesticides</i>	v	
<i>Seedling from the nursery</i>	v	
<i>land use change</i>	v	

**PLANTATION**

<b>Processing Category</b>	<b>Included</b>	<b>Excluded</b>
<i>Energy use of machinery in the plantation</i>	v	
<i>Output to air</i>	v	
<i>Output to water</i>	v	
<i>Output to soil</i>	v	

**MILL**

<b>Processing Category</b>	<b>Included</b>	<b>Excluded</b>
<i>Production, maintenance and replacement of capital equipment</i>	v	
<i>Transportation of capital goods</i>		v
<i>Water treatment and supply</i>	v	
<i>Extraction of crude palm oil from FFB</i>	v	
<i>Transportation of diesel to mill</i>	v	
<i>Management of solid waste in mill</i>	v	
<i>Electricity generation</i>	v	
<i>Production of fuel for boilers</i>	v	
<i>Processing of co-products e.g., palm kernels, palm shells</i>		v
<i>Capital goods</i>	v	
<i>Wastewater treatment</i>	v	

**REFINERY**

<b>Processing Category</b>	<b>Included</b>	<b>Excluded</b>
<i>Production, maintenance and replacement of capital equipment</i>	v	
<i>Transportation of capital goods</i>		v
<i>Transportation of CPO from mill to refinery</i>	v	
<i>Electricity generation</i>	v	
<i>Fuel oil production</i>		v
<i>Transportation of fuel oil from supplier to refinery</i>	v	
<i>Water treatment</i>	v	
<i>Water supply (for steam and chilled water supply)</i>	v	
<i>Phosphoric acid production</i>	v	
<i>Transportation of phosphoric acid to refinery (includes intermediate storage and retailing)</i>	v	
<i>Bleaching earth production</i>	v	
<i>Transportation of bleaching earth to refinery (includes intermediate storage and retailing)</i>	v	
<i>CPO degumming and earth bleaching</i>	v	
<i>Solid waste handling (includes transportation)</i>	v	
<i>Solid waste recycling (includes transportation)</i>	v	
<i>Palm oil deacidification and deodorization</i>	v	
<i>Recovery of palm fatty acid distillate (PFAD) from waste water</i>		v

**REFINERY**

<b>Processing Category</b>	<b>Included</b>	<b>Excluded</b>
<i>On-site waste water treatment</i>	v	
<i>Capital goods use including steel and concrete in buildings and processing plant equipment</i>	v	
<i>RPO fractionation</i>	v	
<i>Storage of PFAD</i>		v
<i>Storage of RPO ( on tank farm)</i>		v
<i>Storage of refined palm olein and refined palm stearin</i>		v

Unit process	Process starts	Nature of transmission	Process ends	Data type (B/F*/)/Data source
Electricity production	Mining and extraction of fossil fuels	Energy conversion	Distribution to the grid at the point of use	B/Malaysian data from SIRIM
Irrigation water supply	Water from surface water	Physical	Water at nursery	F/site specific data
Irrigation	Water at nursery	Physical	Water applied to germinated seeds/seedlings	F/site specific data
Fertilizer production N, P2O5 and K2O	Acquisition of raw materials	Chemical processing	Fertilizers at the production unit gate	B/Ecoinvent database
Transportation of fertilizers N, P2O5 and K2O to nurseries (includes intermediate storage and retailing)	Collection of fertilizers from port in Malaysia to nursery	Physical	Delivery of fertilizers to nursery	B/reference to other site specific data
Application of fertilizers N, P2O5 and K2O (includes incorporation into soil at the recommended dosage)	Fertilizers stored at nursery	Physical	Fertilizers into soil	F/site specific data
Production of insecticides thiocarbamate, pyrethroid and organophosphate	Acquisition of raw materials	Chemical processing	Pesticides at the production unit gate	B/Ecoinvent database
Transportation of insecticides thiocarbamate, pyrethroid and organophosphate to nurseries (include intermediate storage and retailing)	Collection of pesticides from port in Malaysia to nursery	Physical	Delivery of pesticides to nursery	B/reference to other site specific data
Application of insecticides thiocarbamate, pyrethroid and organophosphate (including preparations for application at the recommended dosage)	Pesticides stored at nursery	Physical	Pesticides applied to seedlings	F/site specific data

**PLANTATION**

Unit process	Process starts	Nature of transmission	Process ends	Data type (B/F/**)/Data source
Herbicide production: unspecified herbicide (glufosinate ammonium, urea/sulfonylurea and glyphosate)	Acquisition of raw materials	Chemical processing	Herbicides at the production unit gate	B/Ecoinvent database
Transportation of herbicides: unspecified herbicide (glufosinate ammonium, urea/sulfonylurea and glyphosate) to nurseries (includes intermediate storage and retailing)	Collection of herbicides from port in Malaysia to nursery	Physical	Delivery of herbicides to nursery gate	B/reference to other site specific data
Application of herbicides: unspecified herbicide (glufosinate ammonium, urea/sulfonylurea and glyphosate) (including preparations for application at the recommended dosage)	Herbicides stored at nursery	Physical	Herbicides applied to soil	F/site specific data
Fungicides production: dithiocarbamate	Acquisition of raw materials	Chemical processing	Fungicides at the production unit gate	B/Ecoinvent database
Transportation of fungicides: (dithiocarbamate) to nurseries (includes intermediate storage and retailing)	Collection of fungicides from port in Malaysia to nursery	Physical	Delivery of fungicides to nursery gate	F/reference to other site specific data
Application of fungicides (dithiocarbamate) (including preparations for application at the recommended dosage)	Fungicides stored at nursery	Physical	Fungicides applied to soil	F/site specific data
Polybag production	Acquisition of raw materials	Chemical processing	Polybags at the production unit gate	B/SIRIM database
Transportation of polybags to nurseries (includes intermediate storage and retailing)	Collection of polybags from port in Malaysia to nursery	Physical	Delivery of polybags to nursery gate	B/reference to other site specific data

Unit process	Process starts	Nature of transmission	Process ends	Data type (B/F*/)/Data source
Use of polybags	Polybags stored at nursery	Physical	Polybags used at nursery	B/reference to other site specific data
Top soil supply	Acquisition from land	Physical	Soil for seedling cultivation	B/reference to other site specific data
Transportation of top soil to nurseries (includes intermediate storage and retailing)	Collection of top soil from estate or contractor to nursery	Physical	Delivery of top soil to nursery gate	B/reference to other site specific data
Oil palm seedling cultivation	Acquisition of oil palm germinated seeds	Biological	10- to 12-month-old oil palm seedlings for planting in plantations	B/reference to other site specific data
<b>MILL</b>				
Transportation of FFB to mill	Collection of FFB from the plantation unit gate	Physical	Delivery of FFB to milling unit gate	F/site specific data
Transportation of diesel to mill	Collection of fuel from supplier gate	Physical	Delivery of fuel oil to refining gate	F/site specific data
Extraction of crude palm oil from FFB	FFB as delivered and stored at mill	Physical and Chemical processing	Crude palm oil Palm Oil Mill Effluent (POME)	F/site specific data
Water treatment	Extraction of water from aquifers or surface water (river)	Physical, chemical and biological processing	Potable water at water works gate	B/Ecoinvent database
Water supply (for steam and chilled water supply)	Potable water at water works gate	Physical	Potable water at refining and fractionation unit gate	B/Ecoinvent database
Management of solid waste in mill	FFB, Kernel with retained oil and moisture	Physical, chemical and biological processing	solid waste processing unit	F/site specific data
Biogas capture	POME	Physical	Biogas	F/site specific data
Wastewater treatment	POME after Biogas capture	Chemical and biological processing	Treated waste water (to be discharged)	F/site specific data
Electricity generation	Mining and extraction of fossil fuels	Physical	Distribution to grid at the points of use	B/Ecoinvent database

Unit process	Process starts	Nature of transmission	Process ends	Data type (B/F*/)/Data source
Production of fuel for boilers	Biogas	Energy conversion	fuel for boilers	B/reference to other site specific data
Capital goods	FFB at mill gate	Physical/chemical processing	CPO at mill gate	B and F/Ecoinvent data base, reference to other site specific data
Transportation of CPO from mill to refinery	Collection of CPO from the milling unit gate	Physical	Delivery of CPO to refining unit gate	B and F/Ecoinvent data base, reference to other site specific data
Electricity production	Mining and extraction of fossil fuels	Physical	Distribution to grid at the points of use	B/Ecoinvent database
Electricity usage	Refining gate	Energy conversion	Points of use at the refining and fractionation unit gate	B/reference to other site specific data
Fuel oil production	Mining and extraction of fossil fuels	Physical	Fuel at supplier gate	B/Ecoinvent database
Transportation of fuel oil from supplier to refinery	Collection of fuel from supplier gate	Physical	Delivery of fuel oil to refining gate	B/reference to other site specific data
Fuel usage	Boiler in refinery	Energy conversion	Fuel use for boiler	B/reference to other site specific data
Water treatment	Extraction of water from aquifers or surface water (river)	Physical, chemical and biological processing	Potable water at water works gate	B/Ecoinvent database
Water supply (for steam and chilled water supply)	Potable water at water works gate	Physical	Potable water at refining and fractionation unit gate	B/Ecoinvent database
Phosphoric acid production	Acquisition of raw materials	Physical and chemical processing	Phosphoric acid at the production unit gate	B/Ecoinvent database

**REFINING AND FRACTIONATION PROCESS**



Unit process	Process starts	Nature of transmission	Process ends	Data type (B/F*/)/Data source
Transportation of phosphoric acid to refinery (includes intermediate storage and retailing)	Collection of phosphoric acid from production unit gate	Physical	Delivery of phosphoric acid to refining unit gate	B/reference to other site specific data
Phosphoric acid usage	Phosphoric acid store at refinery	Physical	Phosphoric acid for degumming CPO	B/reference to other site specific data
Bleaching earth production	Acquisition of raw materials	Physical and chemical processing	Bleaching earth at the production unit gate	B/Ecoinvent database
Transportation of bleaching earth to refinery (includes intermediate storage and retailing)	Collection of bleaching earth from production unit gate	Physical	Delivery of bleaching earth to refining unit gate	B/reference to other site specific data
Bleaching earth usage	Bleaching earth store at refinery	Physical	Bleaching earth for adsorptive cleansing of CPO	B/reference to other site specific data
CPO degumming and earth bleaching	CPO as delivered and stored at refinery	Physical and Chemical processing	Degummed, bleached palm oil Solid waster - spent bleaching earth (SBE)	B/reference to other site specific data
Solid waste handling (includes transportation)	SBE with retained oil and moisture	Physical	SBE at landfill	B/reference to other site specific data
Solid waste recycling (includes transportation)	SBE with retained oil and moisture	Physical	SBE and spent earth oil at SBE processing unit gate	B/reference to other site specific data
Palm oil deacidification and deodorization	Degummed, bleached palm oil	Physical processing	Refined palm oil (RPO)	B/reference to other site specific data
Recovery of palm fatty acid distillate (PFAD) from waste water	Waste water from processing of CPO	Physical	Waste water and PFAD	B/reference to other site specific data
On-site waste water treatment	Waste water after recovery of PFAD	Chemical/chemical processing	Treated waste water (to be discharged)	B/reference to other site specific data

Unit process	Process starts	Nature of transmission	Process ends	Data type (B/F*)/Data source
Storage of PFAD	PFAD ready	Physical	PFAD at refining unit gate	B/reference to other site specific data
Storage of RPO (on tank farm)	RPO ready	Physical	RPO at the refining unit gate	B/reference to other site specific data
Capital goods use including steel and concrete in buildings and processing plant equipment	CPO at RPO gate	Physical/chemical processing	RPO at refining and fractionation gate	B and F/Ecoinvent data base, reference to other site specific data
RPO fractionation	Refined palm oil at refining gate	Physical processing	Refined palm olein and palm stearin	B/reference to other site specific data
Storage of refined palm olein and refined palm stearin	Refined palm olein and refined palm stearin ready	Physical	Refined palm olein and refined palm stearin at fractionation unit gate	B/reference to other site specific data



## Appendix 2: Inventory Background Data for LCA Analysis

### Life Cycle Inventory for Plantation Scenario 1 & 2

Output	incl. LULUC	excl. LULUC	Unit	Comment
FFB	17080	17080	kg	Dry matter: 0.30 kg/kg, Gross Energy 24.60 MJ/kg
<b>Input</b>	<b>incl. LULUC</b>	<b>excl. LULUC</b>	<b>Unit</b>	<b>Comment</b>
Water	0	0	m <sup>3</sup>	
Occupation, permanent crop	10000	10000	m <sup>2</sup> a	
Transformation, from forest, unspecified	365.1	0	m <sup>2</sup>	
Transformation, from grassland	12.04	0	m <sup>2</sup>	
Transformation, from permanent crop	2.439	0	m <sup>2</sup>	
Transformation, from annual crop	50.32	0	m <sup>2</sup>	
Transformation, to annual crop	429.9	0	m <sup>2</sup>	
Di ammonium phosphate, as 100% (NH <sub>3</sub> ) <sub>2</sub> HPO <sub>4</sub> (NPK 22-57-0), at plant/RER Mass	8.378	8.378	kg	
Ammonium sulfate, as 100% (NH <sub>4</sub> ) <sub>2</sub> SO <sub>4</sub> (NPK 21-0-0), at plant/RER Mass	30.4	30.4	kg	
NPK compound (NPK 15-15-15), at plant/RER Mass	104.7	104.7	kg	
Urea, as 100% CO(NH <sub>2</sub> ) <sub>2</sub> (NPK 46.6-0-0), at plant/RER Mass	134.8	134.8	kg	
Phosphate rock (32% P <sub>2</sub> O <sub>5</sub> , 50% CaO) (NPK 0-32-0), at mine/RER Mass	75.82	75.82	kg	
Single superphosphate, as 35% Ca(H <sub>2</sub> PO <sub>4</sub> ) <sub>2</sub> (NPK 0-21-0), at plant/RER Mass	25.87	25.87	kg	
Triple superphosphate, as 80% Ca(H <sub>2</sub> PO <sub>4</sub> ) <sub>2</sub> (NPK 0-48-0), at plant/RER Mass	20.39	20.39	kg	
Potassium chloride (NPK 0-0-60), at plant/RER Mass	236.3	236.3	kg	
Potassium sulfate (NPK 0-0-50) (Mannheim), at plant/RER Mass	0.6649	0.6649	kg	
Insecticide, at plant/RER Mass	0.003992	0.003992	kg	
Fungicide, at plant/RER Mass	0.01447	0.01447	kg	
Herbicide, at plant/RER Mass	0.02821	0.02821	kg	

Insecticide emissions, at farm/GLO	0.003992	0.003992	kg	
Fungicide emissions, at farm/GLO	0.01447	0.01447	kg	
Herbicide emissions, at farm/GLO	0.02821	0.02821	kg	
Basic infrastructure, at farm/GLO Mass	1	1	ha	
Transport, truck 10-20t, EURO4, 80%LF, empty return/GLO Mass	51.87	51.87	tkm	
Energy, from diesel burned in machinery/RER Mass	331.3	331.3	MJ	
<b>Emission</b>	<b>incl. LULUC</b>	<b>excl. LULUC</b>	<b>Unit</b>	<b>Comment</b>
Carbon dioxide, fossil	176	176	kg	Lime and dolomite emissions based on tier 1 calculations described in Guidelines for National Greenhouse Gas Inventories (IPCC, 2006)
Carbon dioxide, fossil	98.88	98.88	kg	Fertilizer emissions based on tier 1 calculations described in Guidelines for National Greenhouse Gas Inventories (IPCC, 2006)
Dinitrogen monoxide	1.363	1.363	kg	Direct Fertilizer emissions based on tier 1 calculations described in Guidelines for National Greenhouse Gas Inventories (IPCC, 2006)
Dinitrogen monoxide	0.4431	0.4431	kg	Indirect Fertilizer emissions based on tier 1 calculations described in Guidelines for National Greenhouse Gas Inventories (IPCC, 2006)

Ammonia	14.3	14.3	kg	Fertilizer emissions based on tier 2 ammonia emissions described in Air Pollutant Emission Guidebook (EMEP/EEA, 2016)
Nitrogen monoxide	0.6074	0.6074	kg	Fertilizer emissions based on NO emission based on global mean fertilizer-induced NO emission (EMEP/EEA, 2016)
Dinitrogen monoxide	7.543	0	kg	Direct Emissions from peat oxidation based on peat land emissions described in Guidelines for National Greenhouse Gas Inventories (IPCC, 2006)
Carbon dioxide, fossil	22000	0	kg	Emissions from peat oxidation based on peat land emissions described in Guidelines for National Greenhouse Gas Inventories (IPCC, 2006)
Carbon dioxide, land transformation	8893	0	kg	Land use change impacts based on Direct Land Use Change Assessment Tool 2018, Blonk Consultants, Gouda
Dinitrogen monoxide	0.08611	0.08611	kg	Direct Crop residues emissions based on tier 1 calculations described in Guidelines for National Greenhouse Gas Inventories (IPCC, 2006)
Dinitrogen monoxide	0.01938	0.01938	kg	Indirect Crop residues emissions based on tier 1 calculations described in Guidelines for National Greenhouse Gas Inventories (IPCC, 2006)

Life Cycle inventory for Mill Scenario 1&2

<b>Output</b>	<b>incl. LULUC</b>	<b>excl. LULUC</b>	<b>Unit</b>	<b>Comment</b>
Crude palm oil	200	200	kg	Dry Matter: 1000 g/kg; Gross Energy: 39.13 MJ/kg
Palm kernels	55	55	kg	Dry Matter: 938 g/kg; Gross Energy: 27.06 MJ/kg
<b>Input</b>	<b>incl. LULUC</b>	<b>excl. LULUC</b>	<b>Unit</b>	<b>Comment</b>
Oil palm fruit - ID	1000	1000	kg	
Water, unspecified natural origin, ID	0.7	0.7	m <sup>3</sup>	
Energy, from diesel burned in machinery/RER Mass	30	30	MJ	
Electricity mix, AC, consumption mix, at consumer, < 1kV/ID Mass	0.8	0.8	MJ	
<b>Emission</b>	<b>incl. LULUC</b>	<b>excl. LULUC</b>	<b>Unit</b>	<b>Comment</b>
Methane, biogenic	6.53	6.53	kg	Methane emissions from Palm Oil Mill Effluent
<b>Waste Treatment</b>	<b>incl. LULUC</b>	<b>excl. LULUC</b>	<b>Unit</b>	<b>Comment</b>
Waste water treatment, domestic waste water according to the Directive 91/271/EEC concerning urban waste water treatment, at waste water treatment plant EU-27 S System - Copied from ELCD	650	650	kg	Palm Oil Mill Effluent
Landfill of biodegradable waste EU-27 System - Copied from ELCD	65	65	kg	Palm shells
Landfill of biodegradable waste EU-27 System - Copied from ELCD	230	230	kg	Palm empty fruit bunch
Landfill of biodegradable waste EU-27 System - Copied from ELCD	135	135	kg	Palm fibres
Waste water treatment, domestic waste water according to the Directive 91/271/EEC concerning urban waste water treatment, at waste water treatment plant EU-27 S System - Copied from ELCD	365	365	kg	process water, some also contained in products and effluent

*Life Cycle inventory for Refinery Scenario 2*

<b>REFINERY</b>		
<b>Base: RPO</b>	<b>kg</b>	<b>20</b>
Electricity	kWhr	0.2388
Boiler fuel	MJ	9.5382
Boiler fuel	kg	0.2218
Water	litre	2.2678
Crude palm oil (CPO)	kg	21
Phosphoric acid	kg	0.0118
Bleaching earth	kg	0.1822
<b>Road Transport</b>		
CPO transport (distance) from mill to refinery (28-t truck)	km	2.4
Transport of CPO to refinery tkm	tkm	2.52
Fuel oil transport (distance) from supplier to refinery (28-t truck)	km	10
Transport of fuel oil to refinery	tkm	0.1109
Phosphoric acid transport (distance) from chemical plant to refinery (28-t truck)	km	10
Transport of phosphoric acid to refinery	tkm	0.006
Bleaching earth transport (distance) from chemical plant to refinery (16-t truck)	km	2
Transport of bleaching earth to refinery	tkm	0.0182
Spent bleaching earth transport (distance) from refinery to landfill (16-t truck)	km	0.3
Transport of spent bleaching earth to landfill	tkm	0.0034
<b>Sea Transport</b>		
Phosphoric acid sea transport (distance)	km	300
Transport of phosphoric acid	tkm	0.177
Bleaching earth sea transport (distance)	km	60
Transport of bleaching earth	tkm	0.5466
Waste water	litre	0.8432
Palm fatty acid distillate	kg	0.9124
Spent bleaching earth	kg	0.2218
Waste water biochemical oxygen demand (BOD)	kg	0.0224
Waste water chemical oxygen demand (COD)	kg	0.0652
<b>Fractionation</b>		
Electricity	kWhr	0.1968
Water	litre	1.5254
Cooking oil (Olein)	kg	14.3
Stearin	kg	4.8

## Appendix 3: Detailed Foreground Data for LCA Analysis

No	Item Data	Year					Unit	Information
		2017	2018	2019	2020	2021		
1	<b>TOTAL PRODUCTION</b>							
	CPO (Crude Palm Oil)	33,791,000	30,141,000	29,757,000	34,892,000	30,672,000	kg	
	PKO (Palm Kernel Oil)	7,615,000	8,116,000	7,469,000	9,510,000	7,641,000	kg	
2	<b>ENERGY USE</b>							
	<b>Source of Energy</b>							
	Diesel fuel	0.3148	0.3219	0.2955	0.0124	0.3239	Litre	per 100 kg CPO
	Electricity	16.59	14.48	20.97	2.35	6.60	kWh	per 100 kg CPO
	Energy intensity	0.000443	0.000345	0.000561	0.000047	0.000163	kW	per 100 kg CPO
3	<b>USE OF MATERIALS AND CHEMICALS</b>							
	<b>FERTILIZERS</b>							
	1.Urea	0.621	1.762	0.213	0.861	0.788	Kg	per 100 kg CPO
	2.Dolomite	0.878	2.309	0.523	-	0.965	Kg	per 100 kg CPO
	3.MOP	0.610	1.398	0.156	0.960	0.187	Kg	per 100 kg CPO
	4.Kieserit	0.051	-	-	-	0.008	Kg	per 100 kg CPO
	5.Borate	0.027	0.095	0.052	0.071	0.001	Kg	per 100 kg CPO
	6.TSP	0.275	0.682	0.452	0.502	-	Kg	per 100 kg CPO
	7.LCKS	-	-	-	0.991	-	Kg	per 100 kg CPO
	8.RP	0.196	0.195	0.614	-	-	Kg	per 100 kg CPO
	9.NPK	0.056	0.027	-	-	-	Kg	per 100 kg CPO
	10.Tankos	-	-	-	5.269	-	Kg	per 100 kg CPO
	<b>PESTICIDE</b>							
	1.Amcofur	0.00044	0.01308	0.00030	0.00023	0.00014	Kg	per 100 kg CPO
	2.Nara Up	0.01005	-	-	0.02416	0.01067	Kg	per 100 kg CPO
	3.Racumin	-	-	-	0.00023	0.00074	Kg	per 100 kg CPO
	4.Marshall	0.00194	0.01663	0.00855	0.00861	0.00326	Kg	per 100 kg CPO
	5.Santrino	0.00249	0.00474	0.00144	-	0.00044	Kg	per 100 kg CPO
	6.Klerat	-	0.01108	0.00254	0.00093	-	Kg	per 100 kg CPO
	7.Beta Sipermatine	-	-	-	0.00002	-	Kg	per 100 kg CPO
8.Dithane	-	-	-	0.00005	-	Kg	per 100 kg CPO	



No	Item Data	Year					Unit	Information	
		2017	2018	2019	2020	2021			
3	9.Methyl Metsulfuron	-	-	-	0.00014	-	Kg	per 100 kg CPO	
	10.Starane 480 ec	0.00089	0.00108	0.00049	0.00041	-	Kg	per 100 kg CPO	
	11.Asefat	-	-	-	0.00012	-	Kg	per 100 kg CPO	
	12.Rexroot	-	0.04002	0.00831	-	-	Kg	per 100 kg CPO	
	13..Zhipos	-	0.00040	0.00168	-	-	Kg	per 100 kg CPO	
	14.Koller	-	0.00161	0.00039	-	-	Kg	per 100 kg CPO	
	15.Konidin Klamidospora	-	0.07197	-	-	-	Kg	per 100 kg CPO	
	16.Herb.Sun Up	0.00831	-	-	-	-	Kg	per 100 kg CPO	
	17.Herb.Crash	0.00468	-	-	-	-	Kg	per 100 kg CPO	
	<b>CHEMICALS</b>								
		1. Aluminium sulphate	0.09692	0.08162	0.10115	0.07996	0.09928	Kg	
		2. soda ash	-	0.01294	-	0.00766	0.04018	Kg	
		3. BWT 2041	0.01332	0.01468	0.01227	0.01304	0.01206	Kg	
		4. BWT 2200	0.01003	0.00938	0.00665	0.00929	0.00952	Kg	
		5. BWT 2430	0.00644	0.00705	0.00571	0.00473	0.00424	Kg	
		6. BWT 2520	-	-	-	-	0.00359	Kg	
		7. Caustic Soda	0.00044	0.01145	0.00546	0.00645	0.00473	Kg	
	8. Sulphuric acid	0.00024	0.00637	0.00309	0.00413	0.00261	Kg		
	9. Alcohol	0.00065	0.00075	0.00195	0.00136	0.00220	Kg		
	10. Shell soll	0.00052	0.00050	0.00084	0.00093	0.00057	Kg		
4	<b>WATER USE</b>								
	Source of water:								
	Surface water (River)	0.48396	0.71508	0.61132	0.04262	1.63673	m3	per 100 kg CPO	
	Water intensity	2.9 x 10 <sup>-6</sup>	3.48 x 10 <sup>-6</sup>	4.1 x 10 <sup>-6</sup>	3.55 x 10 <sup>-6</sup>	1.01 x 10 <sup>-6</sup>	m3	per 100 kg CPO	
5	<b>AIR EMISSIONS</b>								
	Source: Genset								
	Total of Particulate	101.10	21.90	11.19	117.00	129.00	mg/Nm <sup>3</sup>		
	CO	125.50	82.51	200.40	332.00	436.00	mg/Nm <sup>3</sup>		
	NO <sub>2</sub>	58.77	74.64	191.80	42.00	63.00	mg/Nm <sup>3</sup>		
	SO <sub>2</sub>	38.00	58.45	26.00	12.00	37.00	mg/Nm <sup>3</sup>		
	O <sub>2</sub>	9.20	9.50	9.10	9.10	9.40	%		
	Flow speed	20.30	21.19	21.20	4.56	5.68	m/s		
	Percentage of Isokinetic	100.05	101.10	100.05	99.89	101.17	%		
6	<b>LIQUID WASTE (PermenLH 5/2014)</b>								
	Debit (Q)						m <sup>3</sup>		

No	Item Data	Year					Unit	Information
		2017	2018	2019	2020	2021		
	pH	7.87	7.93	6.76	7.44	7.9		
	BOD5	112.94	39.81	5.37	6.77	6.38	kg	
	COD	203.61	223.52	18.06	27.17	21.26	kg	
	TSS	63.18	96.99	7.41	8.56	0.44	kg	
	oil and fat	7.38	0.72	1.22	1.26	0.44		
	N - Total						mg/l	
	POME ( <i>Palm Oil Mill Effluent</i> )	0.29526	0.30162	0.30021	0.31693	0.31686		per 100 kg CPO
7	<b>SOLID WASTE</b>							
	Domestic Waste	0.00047	0.00056	0.00056	0.00048	0.00047	Kg	per 100 kg CPO
	Hazardous Waste	0.00487	0.00056	0.00056	0.00048	0.00047	Kg	per 100 kg CPO

## Appendix 4: Detailed Foreground Data PT.SMART for LCA Analysis

No	Item Data	Year					Unit	Information
		2017	2018	2019	2020	2021		
1	<b>TOTAL PRODUCTION</b>							
	CPO (Crude Palm Oil)	70,441,539	72,137,955	74,714,489	68,800,634	64,701,589	Kg	
	PKO (Palm Kernel Oil)	17,031,182	18,198,689	19,260,262	18,379,935	17,407,588	Kg	
2	<b>ENERGY USE</b>							
	<b>Source of Energy</b>							
	Diesel fuel	0.281976	0.208179	0.250886	0.347109	0.391429	Litre	per 100 kg CPO
	Electricity	8.436519	8.044068	8.073943	8.515901	8.321848	kWh	per 100 kg CPO
3	<b>USE OF MATERIALS AND CHEMICALS</b>							
	<b>FERTILIZERS</b>							
	1. Copper Sulfate (CuSO <sub>4</sub> )	0.025329	0.030121	0.028857	0.024076	0.024769	Kg	per 100 kg CPO
	2. HGFB	0.142294	0.142342	0.154364	0.137302	0.137830	Kg	per 100 kg CPO
	3. Kaptan Mesh 80	0.285446	0.708836	0.319617	0.286262	0.363072	Kg	per 100 kg CPO
	4. Kieserite	0.377405	0.488647	0.535706	0.140333	0.010819	Kg	per 100 kg CPO
	5. Muriate of Potash/MOP/KCL	6.117910	8.114452	6.157929	4.790217	7.474623	Kg	per 100 kg CPO
	6. Rock Pospbate (RP)	1.140384	1.037653	0.803060	2.756806	3.677733	Kg	per 100 kg CPO
	7. Super Dolomite	0.193352	0.392581	0.603230	0.571288	4.455918	Kg	per 100 kg CPO
	8. Triple Super Phosphate (TSP)	2.069330	2.813796	2.714668	0.190187	0.298061	Kg	per 100 kg CPO
	9. Urea	4.195607	5.474122	3.813746	0.786435	-	Kg	per 100 kg CPO
	10. Zinc Sulfate (ZnSO <sub>4</sub> )	0.025329	0.030121	0.037809	0.024093	0.026507	Kg	per 100 kg CPO
	11. Urea Coated	-	-	-	2.037481	3.616681	Kg	per 100 kg CPO
	<b>PESTICIDE</b>							
	1. Erkaforon 20 WG	0.001982	0.004551	0.002501	0.006039	0.007256	Kg	per 100 kg CPO
	2. Kao Adjuvant A-134	0.001522	0.004722	0.002821	0.006330	0.007243	Kg	per 100 kg CPO
	3. Roll Up 480 SL	0.008389	0.007799	0.007039	0.009064	0.008394	Kg	per 100 kg CPO
	4. Starane 290 EC	0.001827	0.001369	0.000340	0.000125	-	Kg	per 100 kg CPO
	5. Starane 480 EC	-	0.000016	0.000576	0.001117	0.001181	Kg	per 100 kg CPO
	<b>CHEMICALS</b>							
1. Nalco 2811	0.00043	0.00038	0.00050	0.00065	0.00070	Kg	per 100 kg CPO	
2. Nalco 3273	0.00032	0.00031	0.00038	0.00033	0.00030	Kg	per 100 kg CPO	

No	Item Data	Year					Unit	Information
		2017	2018	2019	2020	2021		
	3. Nalco 22310	-	0.00007	0.00023	0.00029	0.00019	Kg	per 100 kg CPO
	4. Caustic Soda	0.03183	0.03008	0.03226	0.03812	0.03543	Kg	per 100 kg CPO
	5. Sulphuric Acid	0.05321	0.04990	0.05488	0.05221	0.04822	Kg	per 100 kg CPO
	6. Calcium Carbonat	0.49601	0.49586	0.40320	0.46046	0.48121	Kg	per 100 kg CPO
4	<b>WATER USE</b>							
	Source of water:							
	Surface water (River)	0.48396	0.71508	0.61132	0.04262	1.63673	m <sup>3</sup>	per 100 kg CPO
	Water intensity	2.9 x 10 <sup>-6</sup>	3.48 x 10 <sup>-6</sup>	4.1 x 10 <sup>-6</sup>	3.55 x 10 <sup>-6</sup>	1.01 x 10 <sup>-6</sup>	m <sup>3</sup>	per 100 kg CPO
5	<b>AIR EMISSIONS</b>							
	Source: Genset							
	1. CO	-	0.0007098	-	0.0003510	0.0004204	mg/Nm <sup>3</sup>	
	2. CO <sub>2</sub>	-	0.0000034	-	0.0000061	0.0000067	mg/Nm <sup>3</sup>	
	3. TSP	0.0001067	0.0000950	0.000380	0.0002020	0.0001708	mg/Nm <sup>3</sup>	
	4. NO <sub>x</sub>	0.0002442	0.0000681	0.0003380	0.0001366	0.0004057	mg/Nm <sup>3</sup>	
	5. SO <sub>x</sub>	0.0001251	0.0000453	0.0000629	0.0000189	0.0000345	mg/Nm <sup>3</sup>	
	6. O <sub>3</sub>	0.0000140	0.0000452	0.0000462	0.0000372	0.0000740	mg/Nm <sup>3</sup>	
6	<b>LIQUID WASTE (PermenLH 5/2014)</b>							
	Debit (Q)	0.330626	0.304555	0.269087	0.307840	0.306022	m <sup>3</sup>	
	pH	7.13	7.63	7.45	7.75	7.93		
	BOD5	0.004145	0.004338	0.004512	0.004387	0.004179	Kg	
	COD	0.007741	0.008768	0.008511	0.008246	0.007849	Kg	
	TSS						Kg	
	Oil and fat	0.000035	0.000034	0.000033	0.000034	0.000036		
	N - Total						mg/l	
POME ( <i>Palm Oil Mill Effluent</i> )	0.000001	0.000001	0.000001	0.000001	0.000001	Kg	per 100 kg CPO	
7	<b>SOLID WASTE</b>							
	Hazardous Waste	0.004052	0.006205	0.007791	0.008261	0.009151	Kg	per 100 kg CPO

## Appendix 5: Detailed Foreground Data Refinery PT. SMART for LCA Analysis per 100 kg CPO in 2021

No	Item Data	Amount	Unit	Information
1	<b>TOTAL PRODUCTION</b>			
	CPO (Crude Palm Oil)	665061000	Kg	
	RPO (Refined Palm Oil)	630642000	Kg	
2	<b>ENERGY USE</b>			
	<b>Source of Energy</b>			
	Generator	0.008104	kWh	per 100 kg CPO
	Electricity	6.678590	kWh	per 100 kg CPO
3	<b>USE OF MATERIALS AND CHEMICALS</b>			
	<b>CHEMICALS</b>			
	1. Bleaching Earth	0.052145593	Kg	per 100 kg CPO
	2. Phosporic Acid	0.882385225	Kg	per 100 kg CPO
	3. Citric Acid	7.52E-05	Kg	per 100 kg CPO
4	<b>WATER USE</b>			
	Source of water:			
	Ground Water	0.0497244	m3	per 100 kg CPO
5	<b>AIR EMISSIONS</b>			
	Source: Genset			
	1. CO	1.50362E-07	mg/Nm <sup>3</sup>	
	2. CO <sub>2</sub>	7.81883E-07	%	
	3. TSP	2.40579E-07	mg/Nm <sup>3</sup>	
	4. SO <sub>x</sub>	5.11231E-06	mg/Nm <sup>3</sup>	
	5. O <sub>3</sub>	1.50362E-07	mg/Nm <sup>3</sup>	
6	<b>LIQUID WASTE (PermenLH 5/2014)</b>			
	Debit (Q)	0.01617806	m <sup>3</sup>	
	pH	7.86		
	BOD5	3.27789E-06	Kg	
	COD	7.8639E-06	Kg	
	TSS	1.6540E-06	Kg	
	Oil and fat	3.3982E-07	Kg	
	N - Total		mg/l	
7	<b>SOLID WASTE</b>			
	Domestic Waste	0.214257	Kg	per 100 kg CPO
	Hazardous Waste	1.883251	Kg	per 100 kg CPO



